

Applications in Electric Power Market
and Introduction to Gas Detectors and
Alarms for Safety and Security

Document contents

- **About Riken Keiki**
- **Why do we need gas detectors?**
Risks associated with toxic gases
- **Applications in electric power market**
- **Major examples of accidents**
- **Product information**
- **International agents**



About Riken Keiki

About Riken Keiki



RIKEN

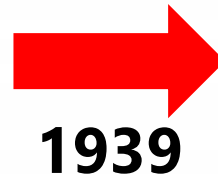

Riken Keiki



**Headquarters
To be completed in September
2018 (conceptual drawing)**

Riken Keiki was originally established to commercialize and sell detectors for preventing explosions in coal mines and on oil tankers.

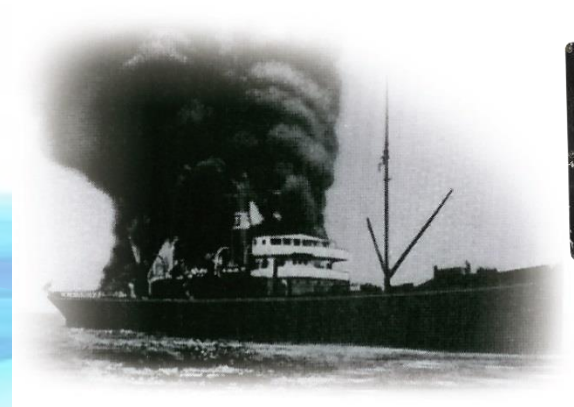

About Riken Keiki



**Methane gas measurements
in coal mine**



**Optical Gas
Indicator Model
3 (1939)**

Certification

National heritage of
analytical and scientific
instruments
2014

Company profile



Company name	Riken Keiki Co., Ltd.	
Established	March 15, 1939	
Location	Headquarters:	2-7-6 Azusawa Itabashi-Ku, Tokyo
	Development Center:	2-3 Minamisakae-cho, Kasukabe-shi, Saitama
Factories	Hakodate-shi, Hokkaido; Sakurai-shi, Nara (affiliated company)	

Headquarters



**To be completed in September 2018
(conceptual drawing)**

Development Center



About Riken Keiki



Headquarters (Itabashi-Ku, Tokyo)



To be completed in September 2018
(conceptual drawing)

Development Center (Kasukabe-shi, Saitama)



Locations of sales offices ◆ Domestic ◆

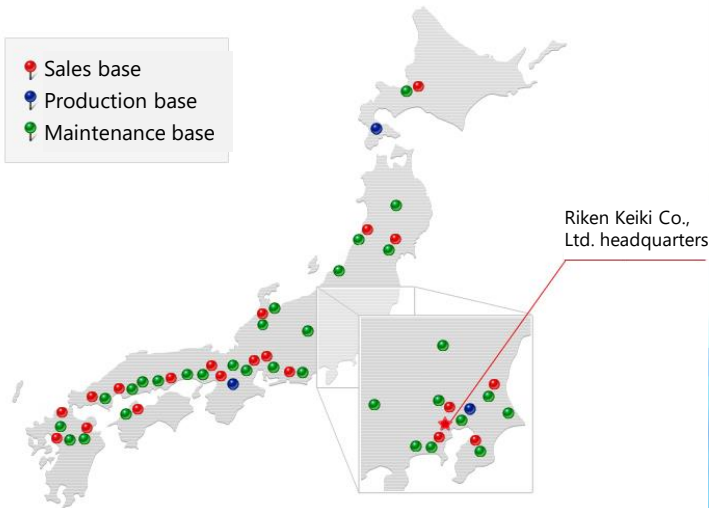

◆ Global ◆

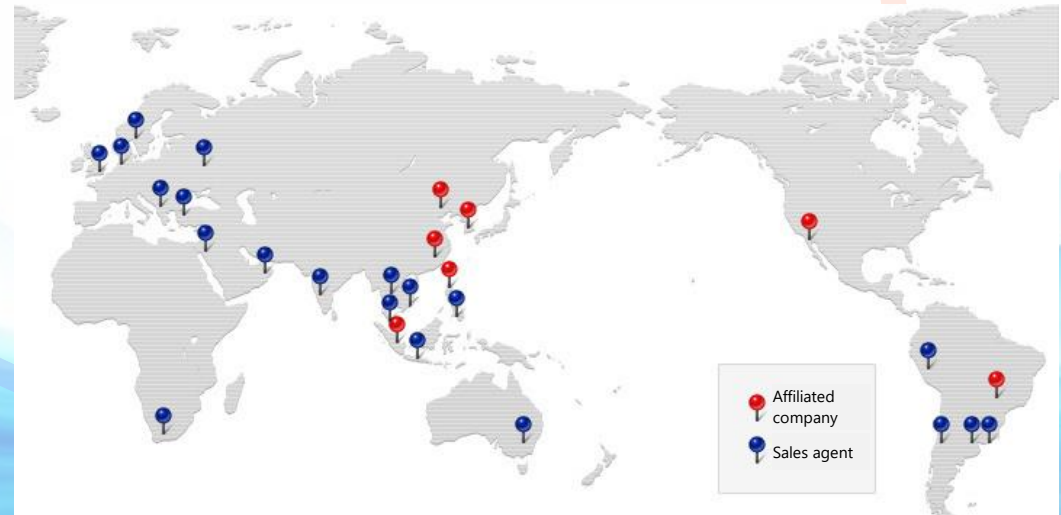

Company profile

Various bases	Domestic sales and branch offices: 20 locations Service stations: 32 locations Global bases: 7 locations
Major sales items	Combustible gas detectors and alarms Gas detectors and alarms designed to prevent oxygen deficiency accidents Toxic gas detectors and alarms Combined gas detectors and alarms Various measuring instruments for environmental measurements and other instruments
Capital	2,565.5 million yen
Number of employees	965 (non-consolidated), 1,127 (consolidated) * As of September 30, 2017

Hakodate Factory
(Hakodate-shi, Hokkaido)



Nara Factory
(Sakurai-shi, Nara)



Company history



1939	Riken Keiki Co., Ltd. established to produce and sell optical gas detectors, photoelasticity apparatuses, and other precision instruments invented and developed by RIKEN
1959	Start production and sale of combustible gas alarms and detectors (catalytic combustion type).
1967	Start production and sale of oxygen measuring instruments (OX-1).
1970	Start production and sale of monitoring tape type measuring instruments (FP-200).
1972	Start production and sale of non-dispersive infrared measuring instruments (RI-550).
1975	Start production and sale of electrochemical type measuring instruments (EC-231).
1986	Start production and sale of photoemission yield spectrometers (AC-1).
2009	70th anniversary of founding
2014	Start production and sale of portable X-ray diffractometers equipped with XRF (DF-01).
2015	Start production and sale of portable multi gas detectors (GX-6000), first product of its kind in Japan capable of housing photoionization detectors (PID).



RIKEN KEIKI

Why Do We Need Gas Detectors? Risks Associated with Toxic Gases

Need for gas detectors (combustible gases)

- **Criteria set by United Nations' Globally Harmonized System of Classification and Labelling of Chemicals (GHS)**

According to the United Nations' Globally Harmonized System of Classification and Labelling of Chemicals (GHS), a combustible gas (or flammable gas) is defined as follows:

A combustible or flammable gas is a gas having an explosive (flammable) range when mixed with air under atmospheric conditions of 20°C and standard pressure of 101.3 kPa.

Gases falling under this definition are further subdivided into the following two categories based on the severity of the associated risk:

Category 1 (Danger: Extremely flammable gas)

Gases capable of igniting at 20°C and standard pressure of 101.3 kPa when occurring in a mixture of 13% or less by volume with air or having an explosive (flammable) range of at least 12% when mixed with air regardless of the lower explosion (flammable) limit

Category 2 (Warning: Flammable gas)

Gases, other than those in Category 1, which are gaseous at 20°C and a standard pressure of 101.3 kPa and have an explosive (flammable) range when mixed with air



We need gas detectors because flammable gas leaks can lead to explosions.

Need for gas detectors (definition of permissible concentration)

● Definition of permissible concentration

Even when workers are exposed to hazardous substances at work sites, no adverse health effects should emerge as long as the airborne concentration of the **hazardous** substance remains below the permissible concentration.

Recommended permissible concentrations have been set by the American Conference of Governmental Industrial Hygienists (ACGIH) and the Japan Society for Occupational Health. We use the **ACGIH** permissible concentrations.

● Types of permissible concentrations

• TWA (Time Weighted Average)

Time Weighted Average refers to time-weighted average concentrations over an 8-hour workday and 40-hour workweek of routine work to which workers may be repeatedly exposed without adverse health effects.

• STEL (Short Term Exposure Limit)

Short Term Exposure Limit refers to exposure that does not lead to adverse health effects if each exposure does not exceed 15 minutes, the number of daily exposures does not exceed four, and the exposures are separated by at least one hour.

• C (Ceiling value)

Ceiling Value refers to the upper limit that can never be exceeded.



We need gas detectors because leaks exceeding permissible concentrations can lead to accidents.

How human body reacts to oxygen-deficiency

O2 Concentration
21%



Symptoms
Natural air

O2 Concentration
18%



Symptoms
Limit level for not causing serious health problems. Continuous ventilation is required



O2 Concentration
16% - 12%

Symptoms
Rapid breathing,
Increase in pulse rate,
Loss of concentration,
Headache, Nausea,
Ear ringing



O2 Concentration
14% - 9%



Symptoms
Stupor, Headache,
Nausea, Cyanosis,
Faintness on the entire
body

O2 Concentration
10% - 6%

Symptoms
Comatose, Loss of consciousness,
Muscle spasm on the entire body



O2 Concentration
6% or less

Symptoms
Unconsciousness, Comatose,
Cessation of breathing,
Cardiac arrest, Die in 6 minutes

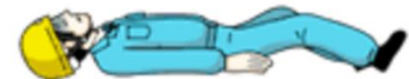

Effects of hydrogen sulfide (H₂S) on human body

Concentration (ppm)	Effects and Toxicity
0.025	Smell vaguely. (It varies according to the individual.)
0.3	Smell clearly.
3 - 5	Smell moderate degree of objectionable odor.
10	Lower-level to irritate eyes' mucus membranes.
20 - 40	A strong odor. Lower-level to irritate lungs' mucous membranes.
100	Sense of smell is impaired in 2 - 15 minutes. Eyes and respiratory tract are irritated in 1 hour. 8 - 48 hours continuous exposure can lead to death.
170 - 300	1 hour exposure is the limit for not causing serious health problems.
400 - 700	Life-threatening exposure in 0.5 - 1 hour.
800 - 900	Bring on loss of consciousness, cessation of breathing and death.
1000	Bring on immediate loss of consciousness and death.

Effects of carbon monoxide (CO) on human body

Concentration (ppm)	Effects and Toxicity
100	No noticeable effects even after breathing for a few hours.
200	A mild headache in around 1.5 hours.
400 - 500	Headache, nausea and ear ringing in around 1 hour.
600 - 1000	Loss of consciousness in around 1 - 1.5 hours.
1500 - 2000	Headache, vertigo and disabling nausea in around 0.5 - 1 hour, and losing consciousness.
3000 - 6000	Headache, vertigo, disabling nausea...etc. in a few minutes. 10 - 30 minutes exposure can lead to death.
10000	Bring on immediate loss of consciousness and death.

Applications in Electric Power Market

Applications in electric power market

1. Overview of processes at thermal power stations (coal-fired/oil-fired steam power generation)
2. Overview of processes at thermal power stations (natural-gas-fired GTCC power generation)
3. Details of individual processes at thermal power stations
 - 3-1: Coal silo
 - 3-2: Coal silo discharge conveyor
 - 3-3: Coal bunker
 - 3-4: Oil tank
 - 3-5: Boiler
 - 3-6: Turbine generator
 - 3-7: Condenser
 - 3-8: Substation
 - 3-9: Flue-gas denitrification unit
 - 3-10: LNG loading arm
 - 3-11: LNG tank
 - 3-12: LNG pump and peripheral equipment
 - 3-13: NG header and gas turbine
 - 3-14: Gas turbine enclosure
4. Biogas power generation
5. Wood biomass gasification power generation
6. Geothermal power generation

1. Overview of processes at thermal power stations (coal-fired/oil-fired steam power generation)

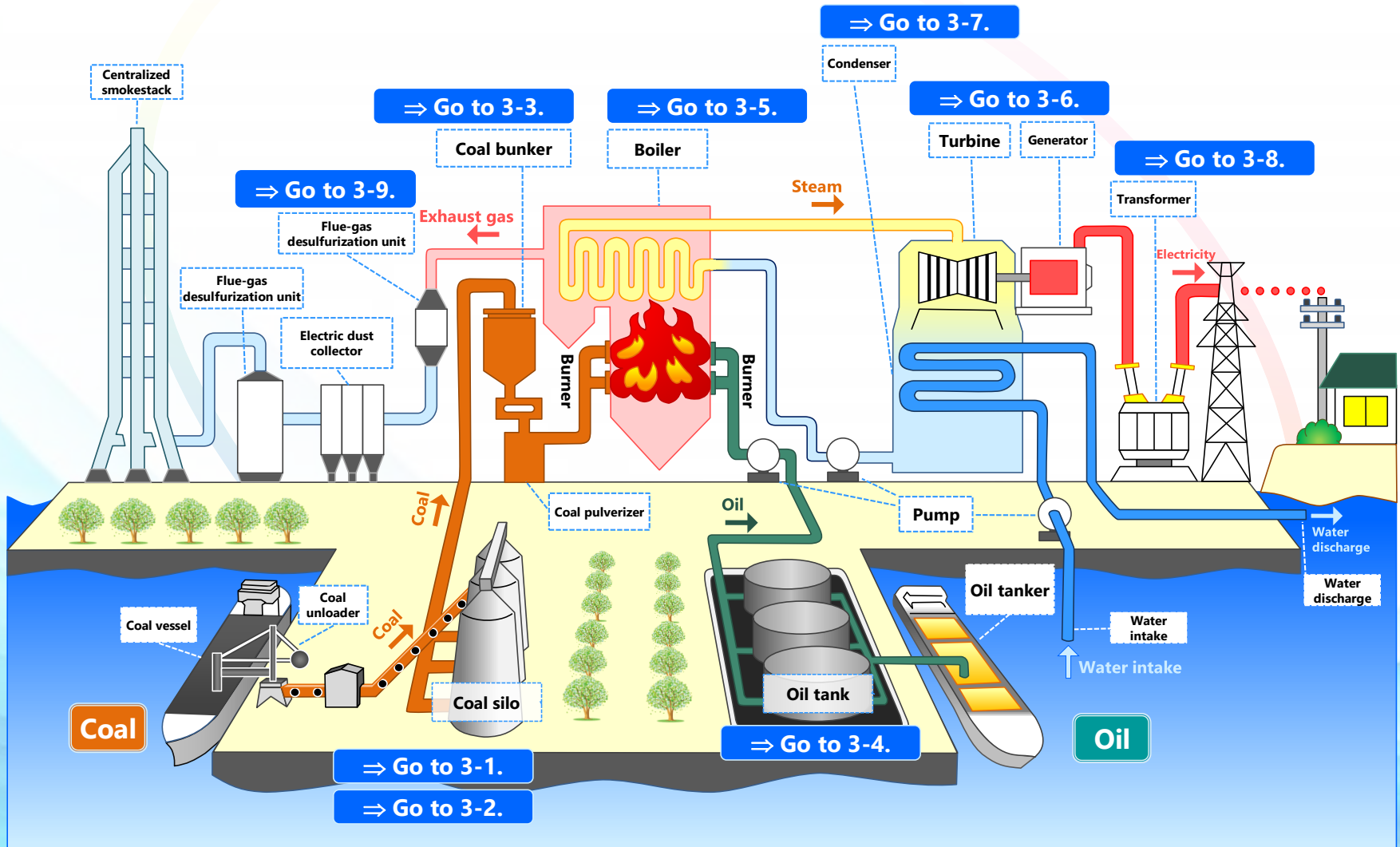

2. Overview of processes at thermal power stations (natural-gas-fired GTCC power generation)

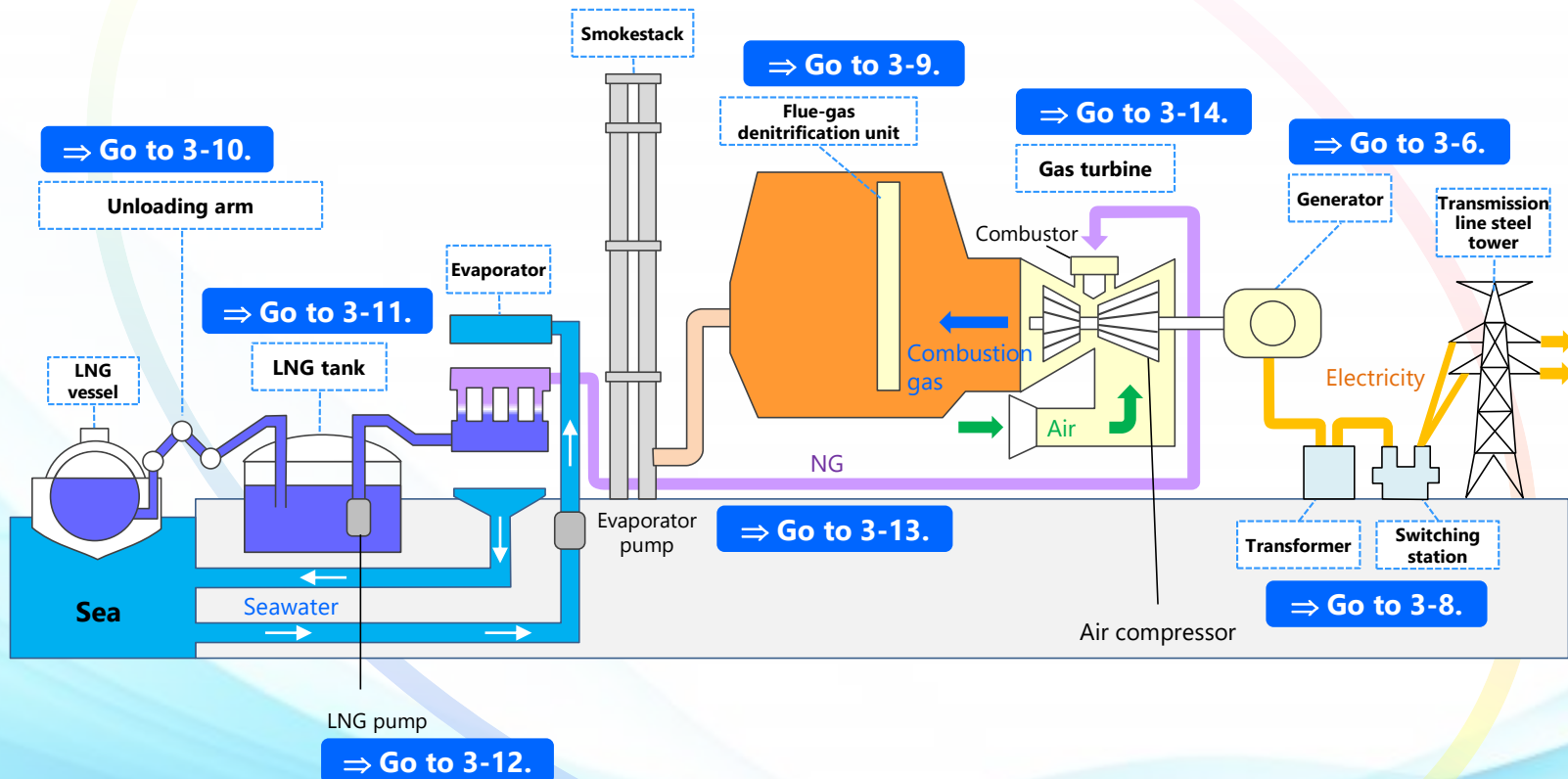

3-1: Coal silo

Description: Coal unloaded from the coal vessel is transferred via a belt conveyor to the coal silo for temporary storage.

- Hazardous risks:** CH₄ generated from coal poses explosion risk. ⇒ Detecting CH₄ to prevent explosions
 Coal can spontaneously ignite within the silo. ⇒ Detecting CO produced during initial coal smoldering (low-temperature oxidation) to prevent early outbreak of fire
 Enclosed environment and coal oxidation pose risk of oxygen deficiencies. ⇒ Measuring oxygen concentrations to prevent oxygen deficiencies

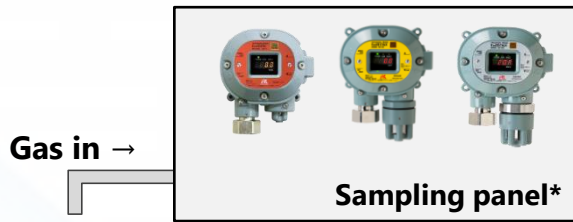

* Depending on sampling conditions, separate suction pumps and pre-processing equipment may be required.

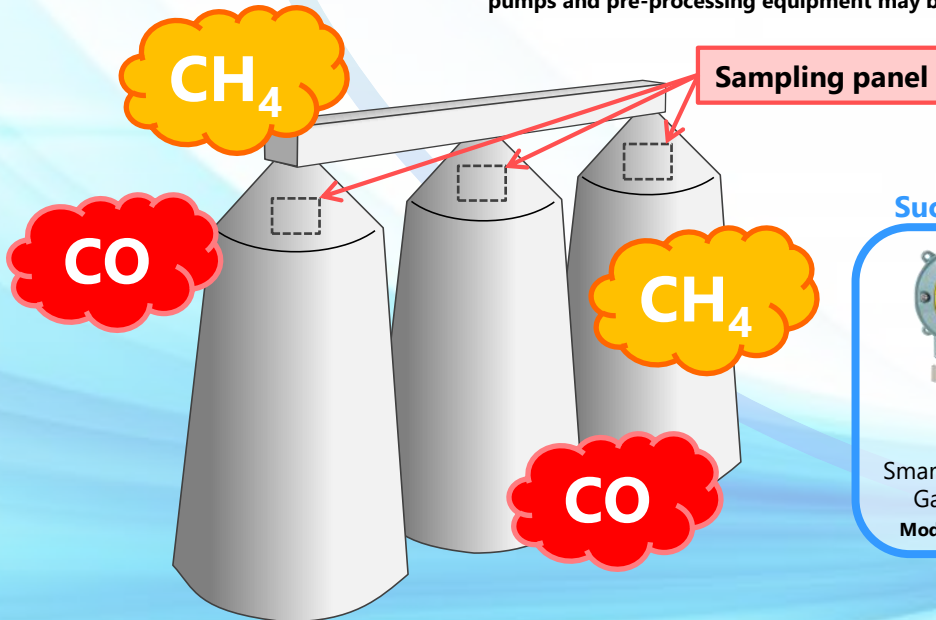

Suction type CH₄ detector head



Smart Transmitter/
Gas Detector
Model: SD-1D
Model: SD-1DRI

Explosion-proof
Pump
Model: RP-D58

Suction type CO detector head

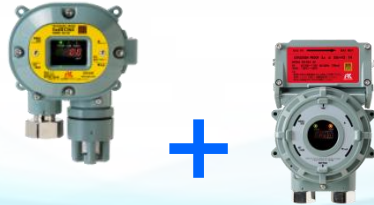

Smart Transmitter/
Gas Detector
Model: SD-1DEC

Explosion-proof pump
Model: RP-D58

Suction type oxygen deficiency detector head

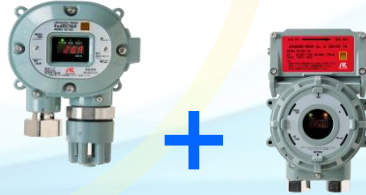

Smart Transmitter/
Gas Detector
Model: SD-1DOX

Explosion-proof
Pump
Model: RP-D58

3-2: Coal silo discharge conveyor

Description: Coal stored in the coal silo is transferred via a belt conveyor to the coal bunker in accordance with power station operating requirements.

- Hazardous risks:** CH₄ generated poses explosion risk. ⇒ Detecting CH₄ to prevent explosions
- Coal may spontaneously ignite within the silo. ⇒ Detecting CO produced during initial smoldering of coal (low-temperature oxidation) to prevent early outbreak of fire
- Enclosed environment and coal oxidation pose risk of oxygen deficiencies. ⇒ Measuring oxygen concentrations to prevent oxygen deficiencies

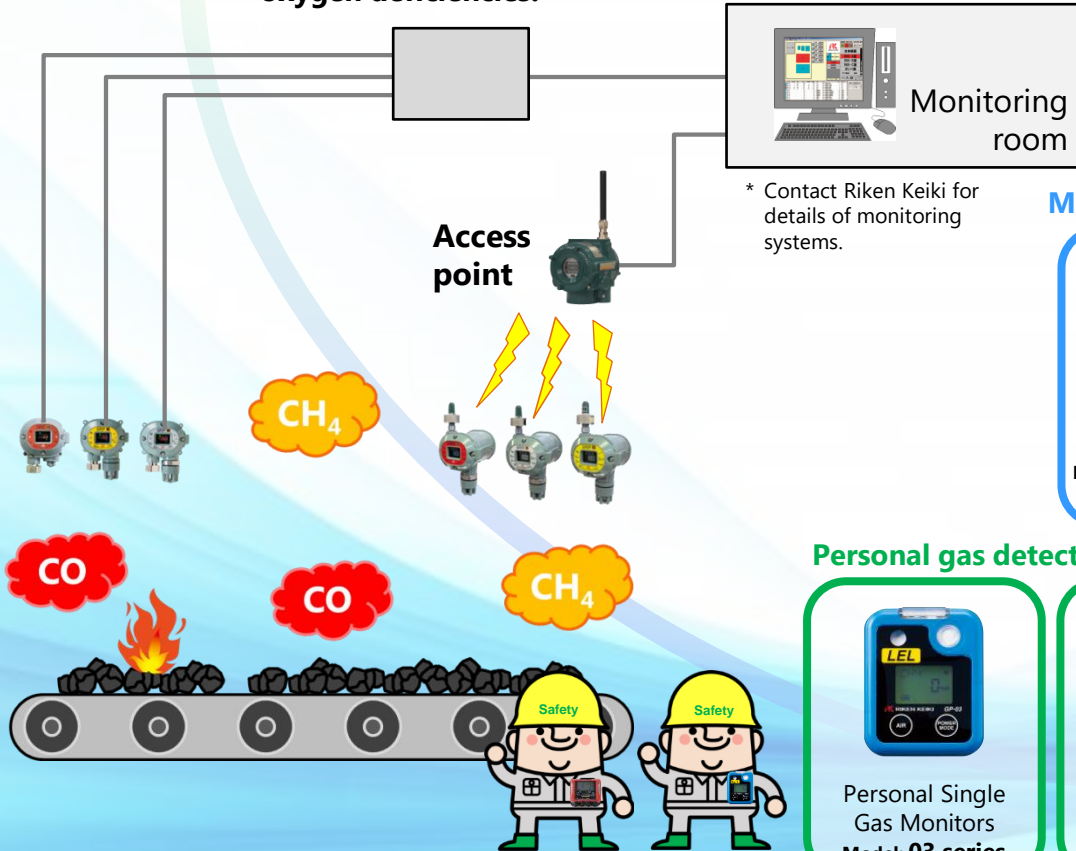

* Contact Riken Keiki for details of monitoring systems.

CH₄ detector heads



Smart Transmitter/
Gas Detector
Model: **SD-1**
Model: **SD-1RI**



Fixed Wireless
Gas Detector
Model: **SDWL-1RI**

Monitoring system



Gas Leakage
Monitoring System
Model: **Riken Keiki
Kanshiro**

CO detector heads



Smart Transmitter/
Gas Detector
Model: **SD-1EC**



Fixed Wireless
Gas Detector
Model: **SDWL-1EC**

Personal gas detectors for workers



Personal Single
Gas Monitors
Model: **03 series**



Four Gas Personal
Monitor
Model: **GX-2009**

Oxygen deficiency detector heads



Smart Transmitter/
Gas Detector
Model: **SD-10X**



Fixed Wireless
Gas Detector
Model: **SDWL-10X**

3-3: Coal bunker

Description: Coal transferred via a belt conveyor is stored in the coal bunker to be supplied to the coal pulverizer.

Hazardous risks: Coal may spontaneously ignite within the coal bunker.

⇒ Detecting CO produced during initial smoldering of coal (low-temperature oxidation) to prevent early outbreak of fire

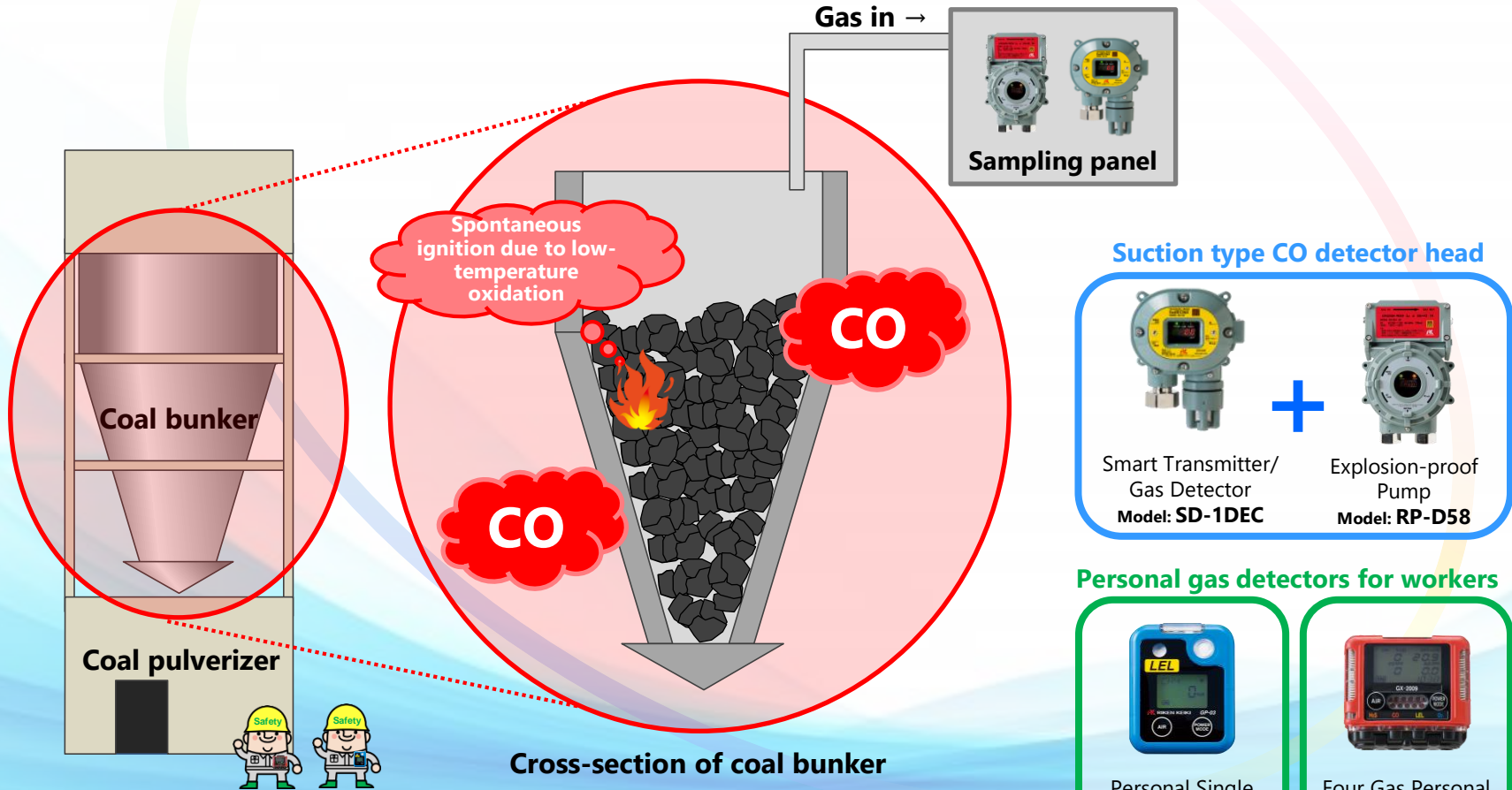

Cross-section of coal bunker

Suction type CO detector head



Smart Transmitter/
Gas Detector
Model: SD-1DEC



Explosion-proof
Pump
Model: RP-D58

Personal gas detectors for workers



Personal Single
Gas Monitor
Model: 03 series



Four Gas Personal
Monitor
Model: GX-2009

3-4: Oil tank

Description: Oil unloaded from an oil tanker is transferred to the oil tank via a pipeline for temporary storage.

Hazardous risks: Hydrocarbons (combustible gases) vaporizing from the oil pose explosion risk.

⇒ Detecting combustible gases to prevent explosions

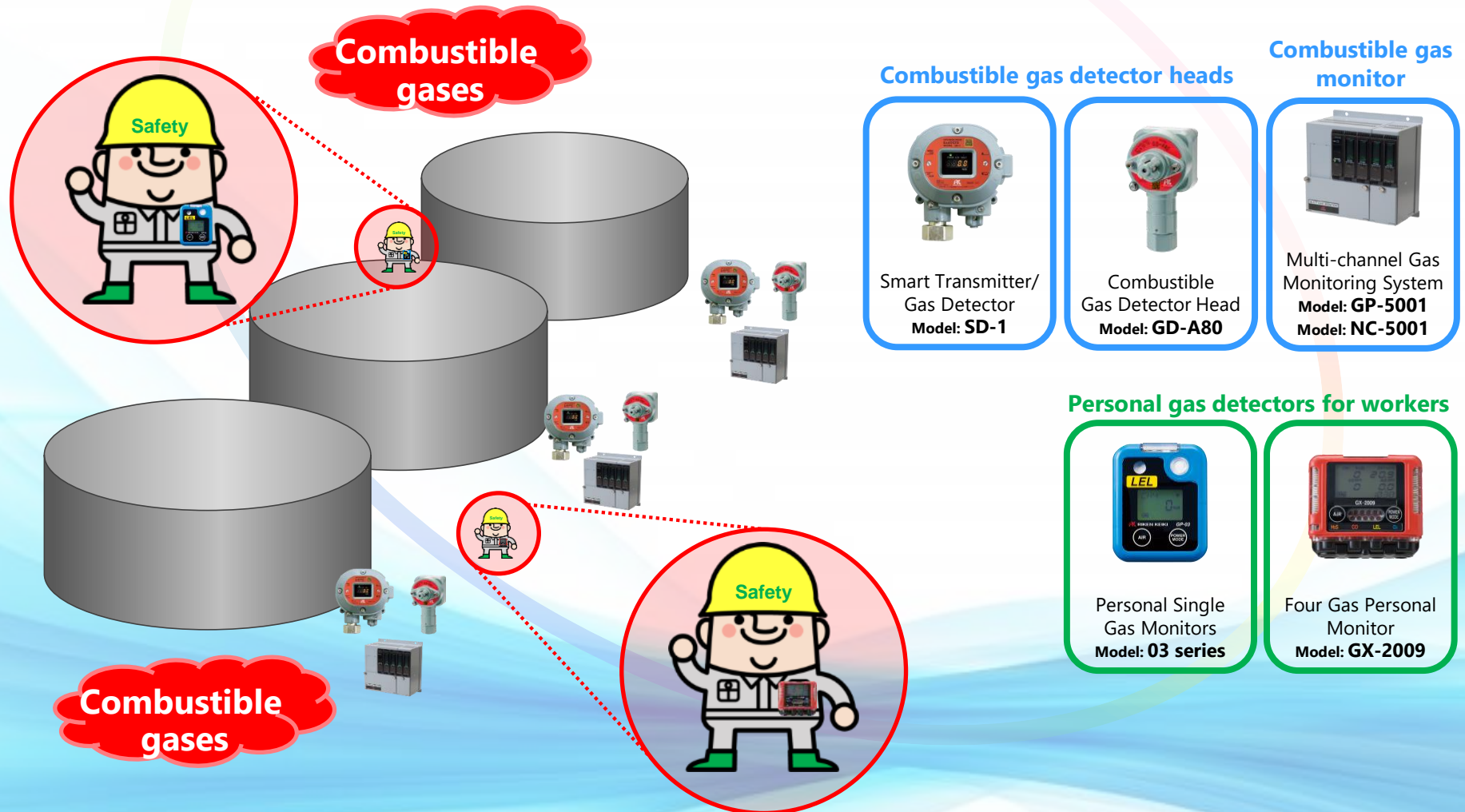

Combustible gases

Combustible gas detector heads

Combustible gas monitor



Smart Transmitter/
Gas Detector
Model: SD-1



Combustible
Gas Detector Head
Model: GD-A80



Multi-channel Gas
Monitoring System
Model: GP-5001

Personal gas detectors for workers



Personal Single
Gas Monitor
Model: 03 series



Four Gas Personal
Monitor
Model: GX-2009

Combustible gases

3-5: Boiler

Description: Pulverized coal and oil is burned in the boiler to produce high-temperature, high-pressure steam, which is then sent to the turbine.

Hazardous risks: CO generated by incomplete combustion in the boiler poses poisoning risk. ⇒ Detecting CO to prevent poisoning

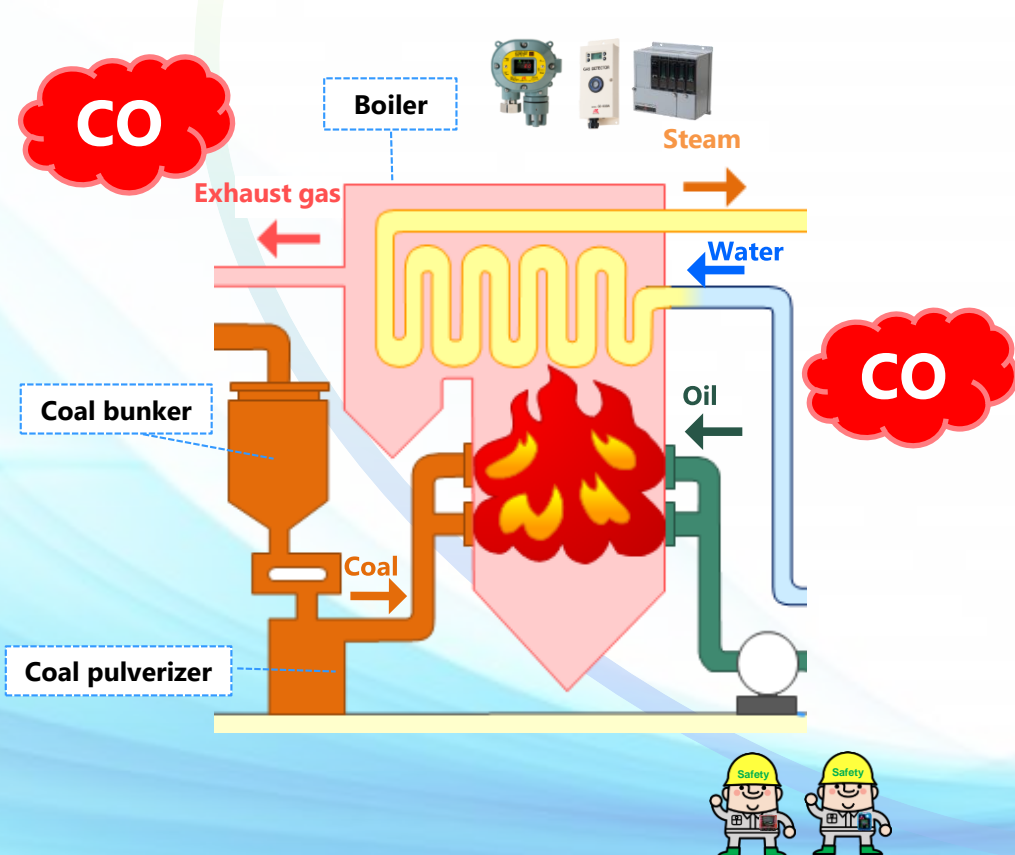

CO detector heads

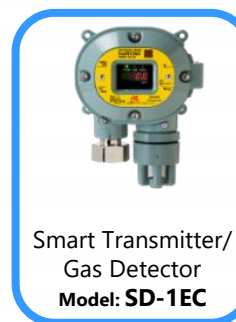

Toxic gas monitor



Personal CO gas detectors for workers



3-6: Turbine generator

Description: Steam sent from the boiler drives the turbine rotors to generate electricity in a generator coupled to the turbine. The steam generated within the generator is cooled using coolant such as hydrogen gas.

Hazardous risks: Leaks of hydrogen gas used as coolant inside the generator pose explosion risk.

⇒ Detecting hydrogen gas to prevent explosions

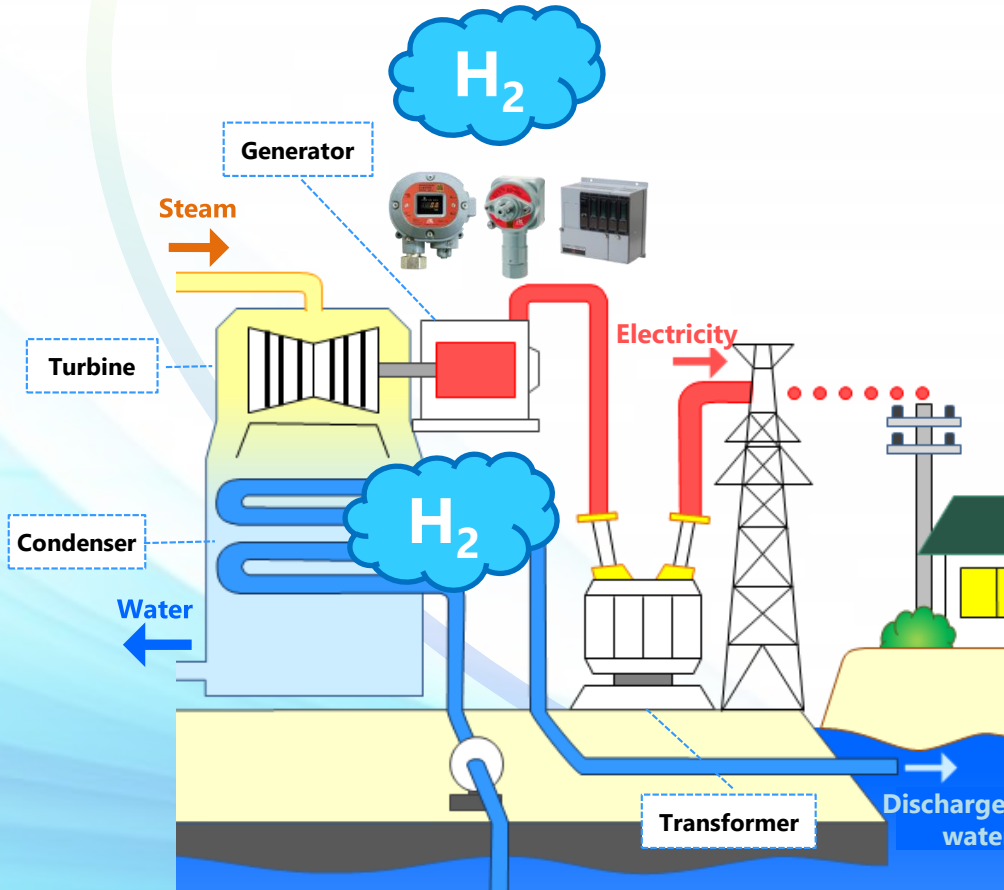

H₂ detector heads

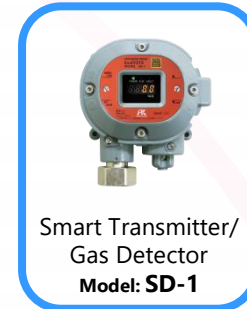

H₂ monitor Pre-work gas detector

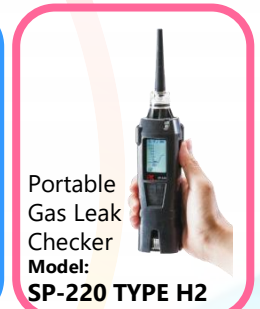

Pre-work gas detectors



3-7: Condenser

Description: The steam used to operate the turbine is cooled in the condenser, where it condenses back to water. This is returned to the boiler, where it becomes steam once again. The process is continually repeated. The condenser uses a large volume of seawater to cool the steam.

Hazardous risks: Decaying shellfish inside the condenser seawater intake pipe poses risk of hydrogen sulfide poisoning and oxygen deficiencies.

⇒ Detecting hydrogen sulfide to prevent poisoning and detecting oxygen to prevent oxygen deficiencies

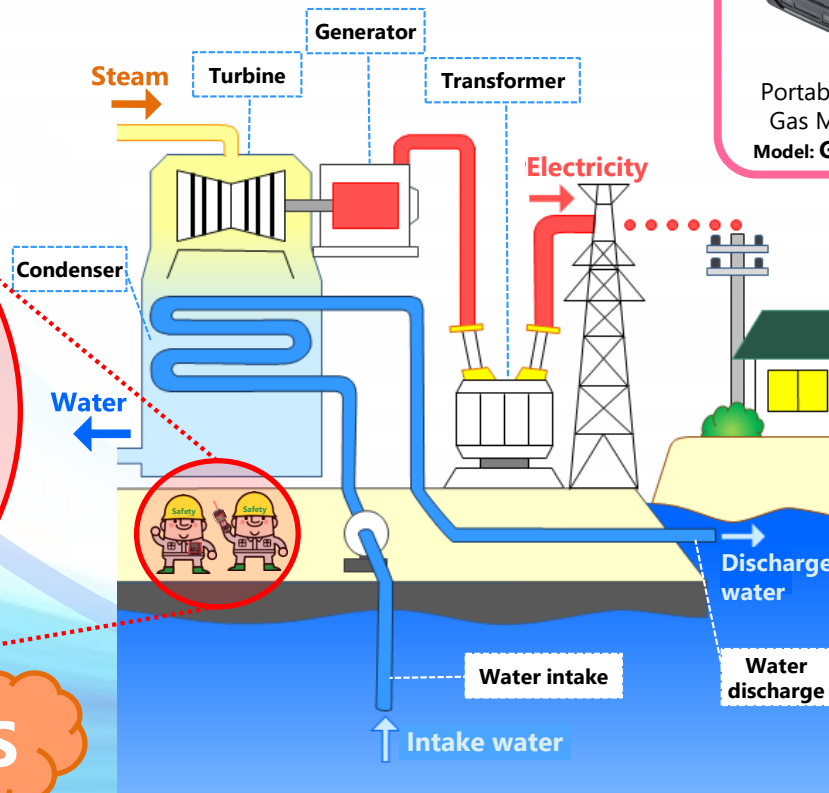
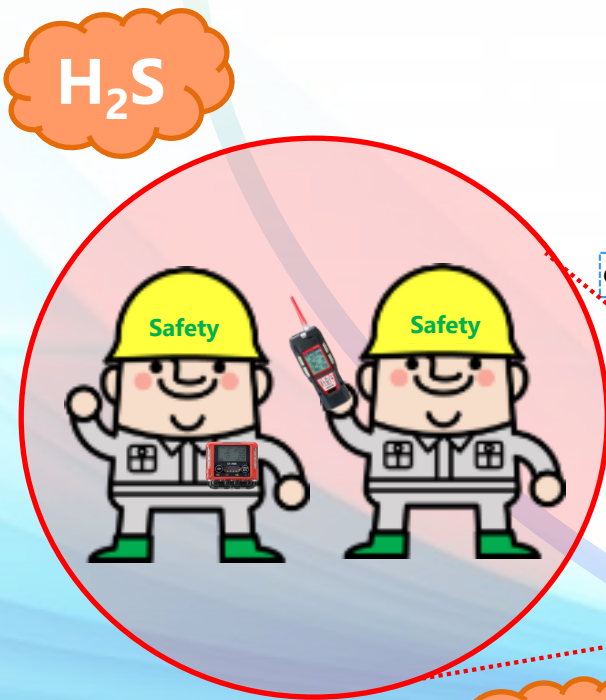

Pre-work gas detectors



Portable Multi Gas Monitor
Model: GX-8000



Portable Multi Gas Detector
Model: GX-6000

Personal gas detector for workers



Four Gas Personal Monitor
Model: GX-2009



3-8: Substation

Description: The substation includes a transformer to control the voltage of the electricity supplied from the generator and a circuit-breaker to shut off the power in the event of problems. These facilities use sulfur hexafluoride (SF_6) as an insulating gas.

Hazardous risks: SF_6 leaks occurring during maintenance to the transformer and circuit-breaker equipment may damage the environment if released. ⇒ Measuring SF_6 to minimize environmental effects

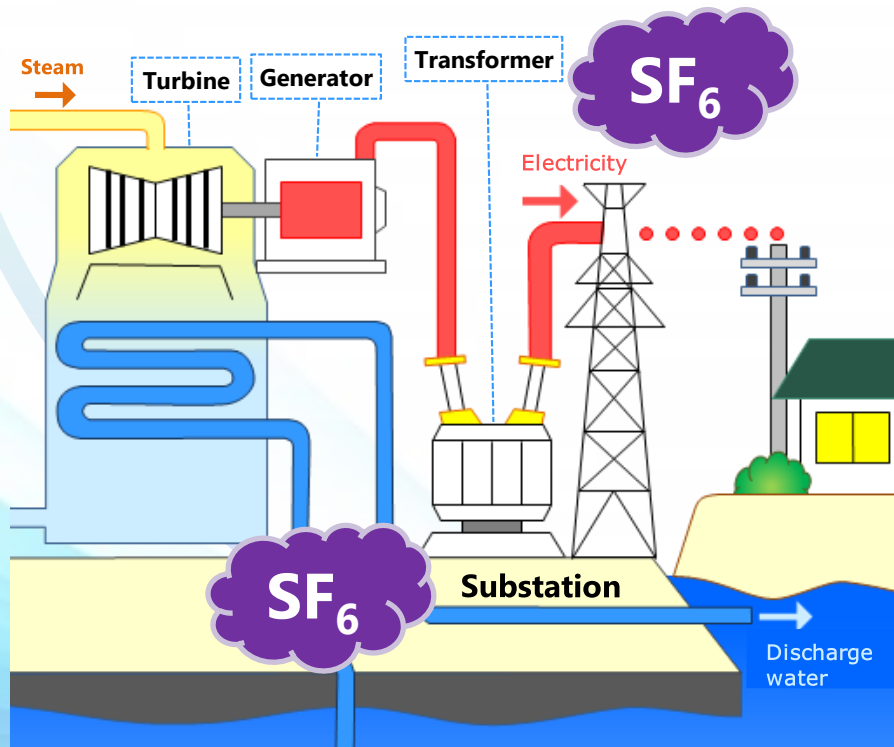

SF_6 gas detector



3-9: Flue-gas denitrification unit

Description: Combustion of coal, oil, and LNG in the boiler results in oxidation of the nitrogen contained in these fuels, producing NO_x, atmospheric pollutants. Flue gases containing NO_x are sprayed with ammonia (NH₃) in the flue-gas denitrification unit situated at a postprocessing stage, which decomposes NO_x into nitrogen and water to remove the NO_x.

Hazardous risks: NH₃ leaks from the flue-gas denitrification unit pose risk of poisoning. ⇒ Detecting NH₃ to prevent poisoning

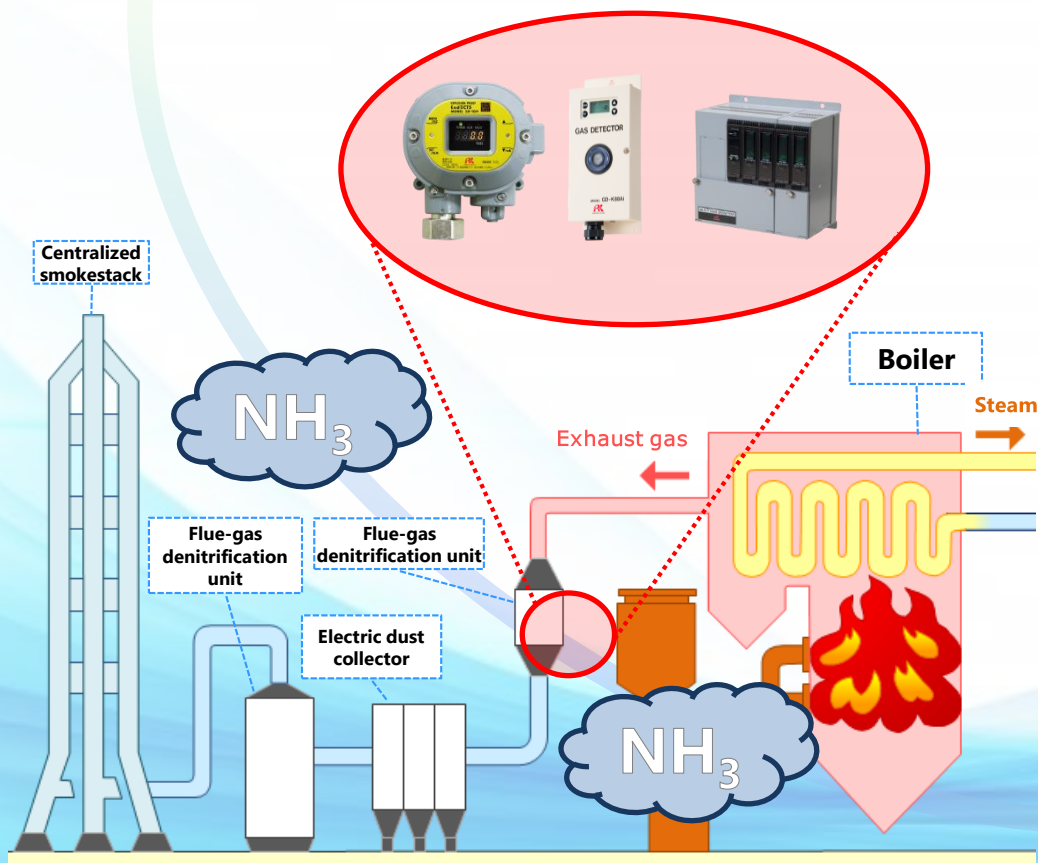

NH₃ detector heads



Toxic gas monitor

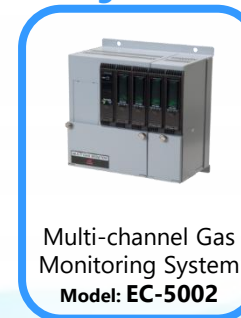

Pre-work gas detector head



3-10: LNG loading arm

Description: LNG transported by LNG tanker is transferred to the LNG tank by a loading arm.

Hazardous risks: Leaking CH_4 (the main constituent of LNG) during transfer via the loading arm poses explosion risk.

⇒ Detecting CH_4 within N_2 to prevent explosions (infrared detection)

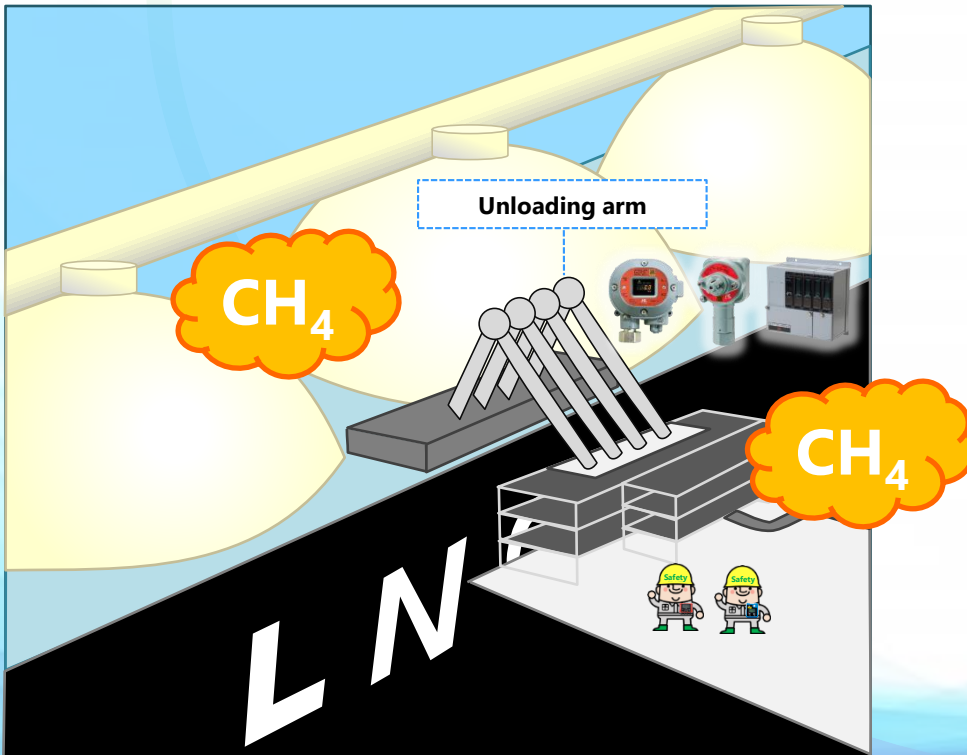

Combustible gas detector heads



Smart Transmitter/
Gas Detector
Model: **SD-1RI**
(Infrared detection)



Combustible Gas
Detector Head
Model: **GD-A80**



Multi-channel
Gas Monitoring
System
Model: **GP-5001**
Model: **NC-5001**

Personal gas detectors for workers



Personal Single
Gas Monitor
Model: **GP-03**



Four Gas Personal
Monitor
Model: **GX-2009**

3-11: LNG tank

Description: The LNG tank contains a refrigerant between the inner tank and outer tank to prevent external heating of the tank and to minimize evaporation of the LNG. Nitrogen (N_2) is also contained to prevent a reduction in the insulating properties due to moisture absorption by the refrigerant.

Hazardous risks: There is a risk of LNG leakage into the N_2 atmosphere between the inner and outer tanks.

⇒ **Monitoring combustible gas within N_2 using a suction type detector**

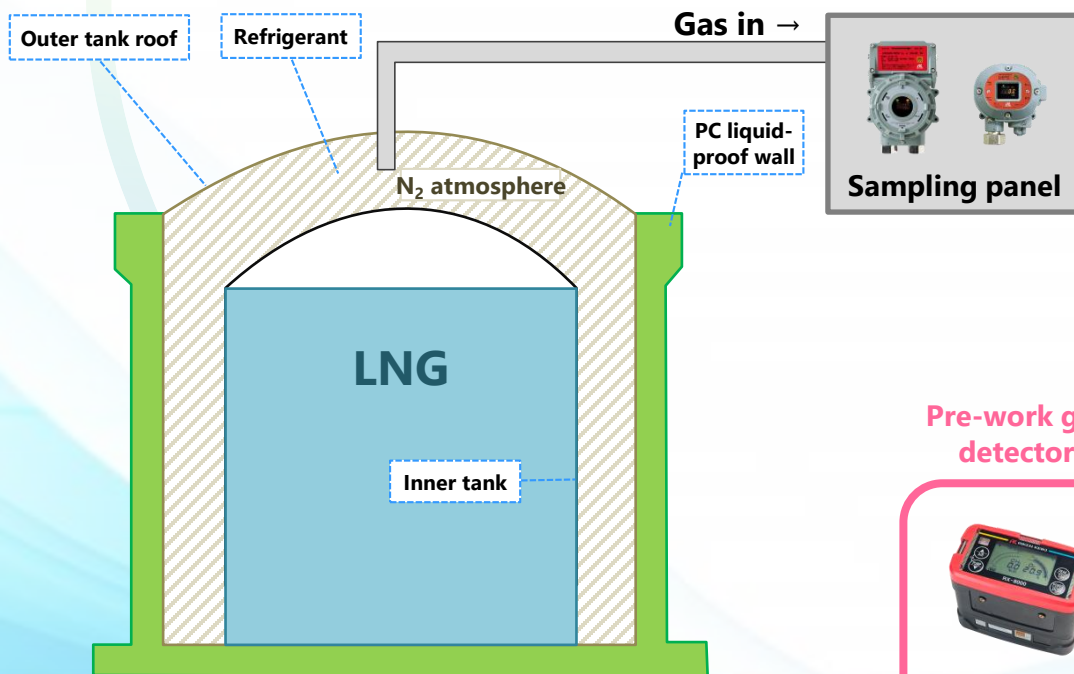

Suction type CH_4 detector head (infrared type)

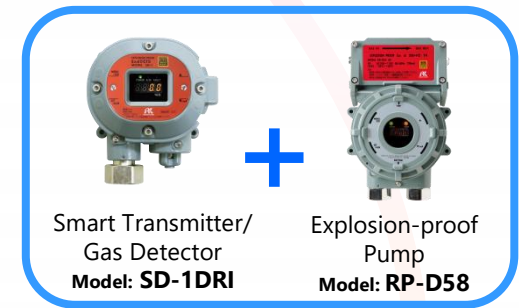

Pre-work gas detector



Suction type CH_4 detector head (semiconductor type)

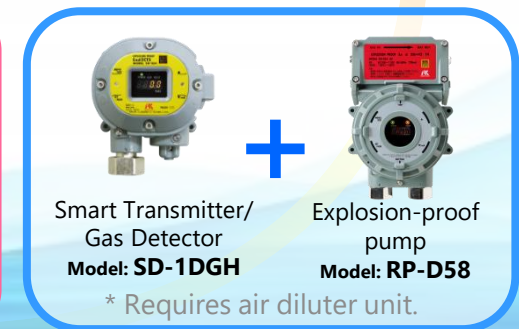

3-12: LNG pump and peripheral equipment

Description: The LNG tank includes an LNG pump for transferring the LNG inside the tank to the turbine and other peripheral equipment.

Hazardous risks: CH₄ leaks from the LNG pump or peripheral equipment ⇒ Detecting CH₄ to prevent explosions

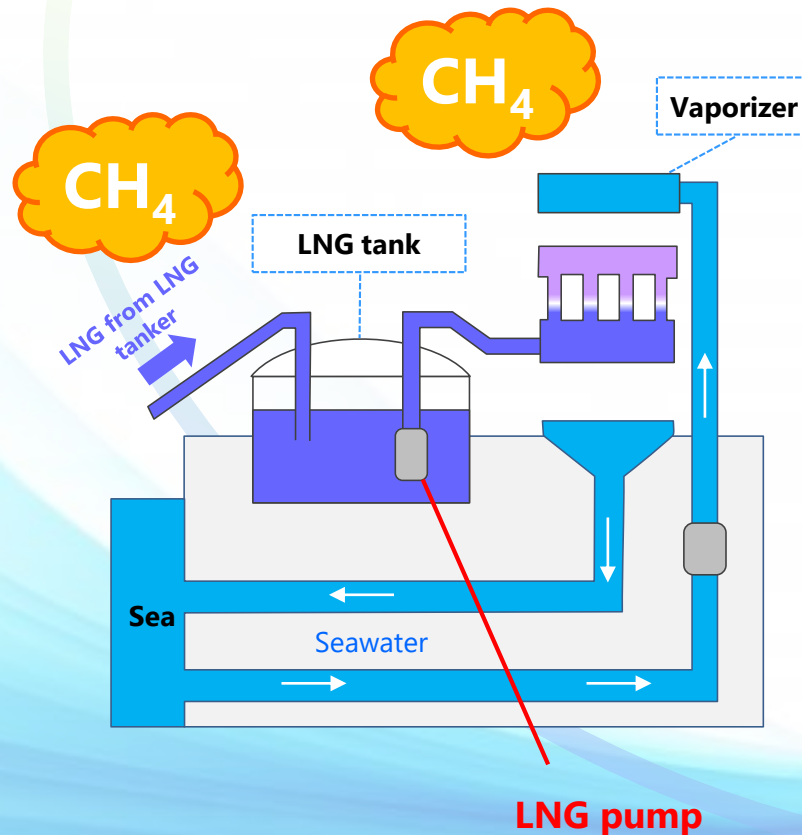

Combustible gas detector heads



Combustible gas monitor

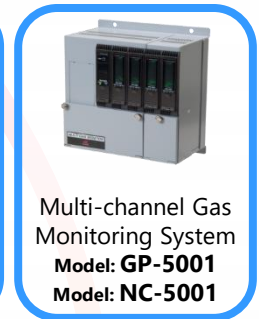

Personal combustible gas detectors for workers



3-13: NG header and gas turbine

Description: LNG is vaporized in the vaporizer to become natural gas (NG). NG is then supplied to the turbine via the NG header.

Hazardous risks: Gas turbine operations may be affected by variations in the calorific value of the gas caused by diversification of LNG import sources, an increase in BOG* processing, and adoption of shale gas. ⇒ Measuring calorific value online using a gas calorimeter and sending control signals to the gas turbine

* BOG (boil off gas): Gas formed by vaporization of part of LNG stored in a tank

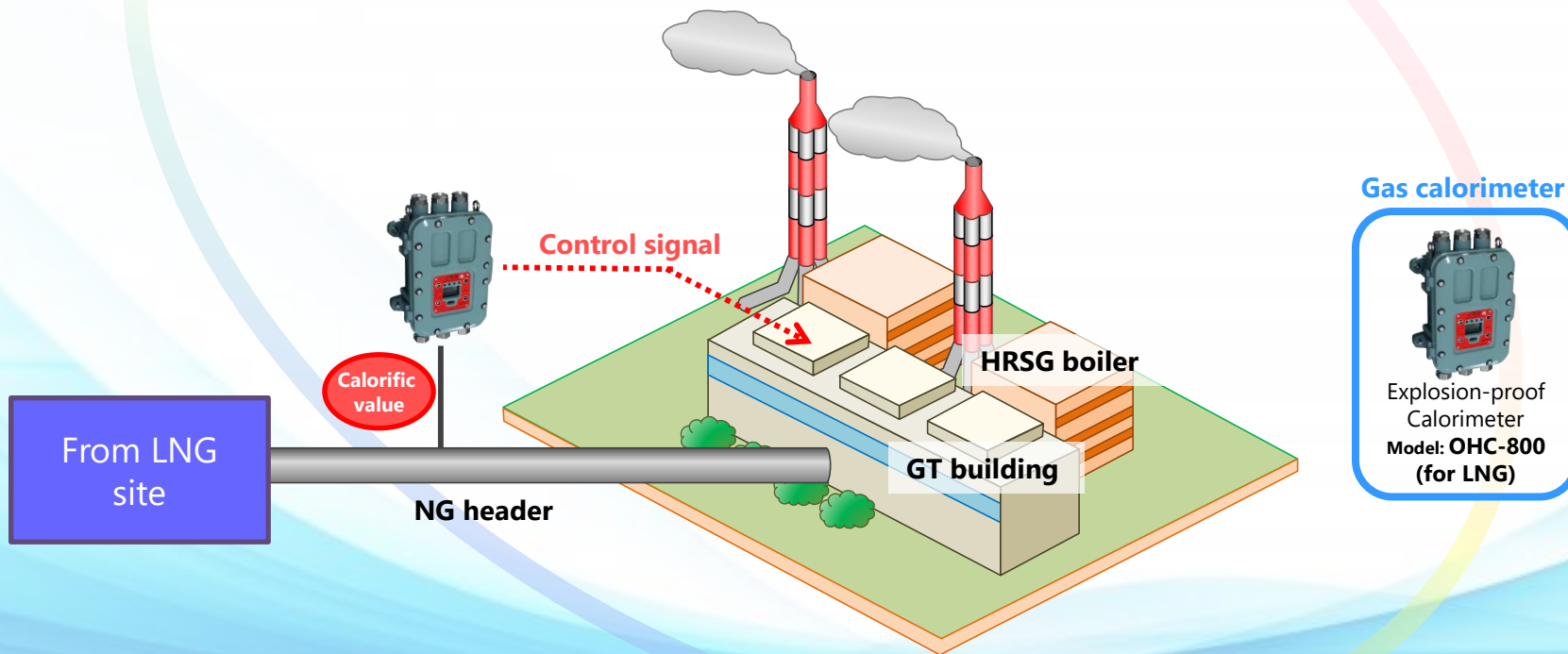

3-14: Gas turbine enclosure

Description: The gas turbine enclosure is a building that houses the main components of the gas turbine generator to protect them. This structure also reduces noise.

Hazardous risks: CH₄ leaks inside the gas turbine enclosure ⇒ Detecting CH₄ to prevent explosions pose explosion risk.

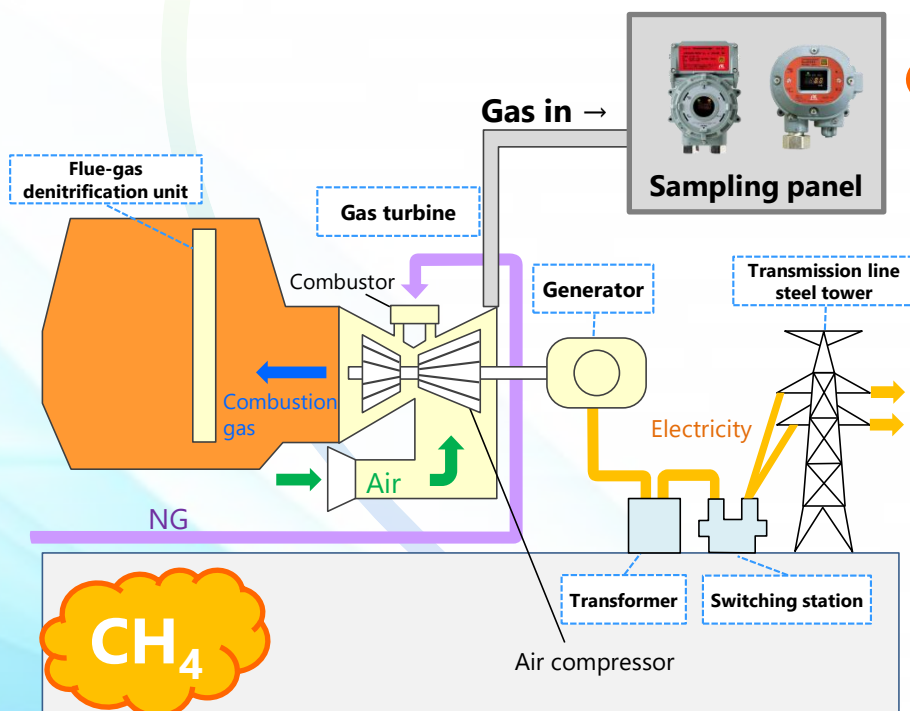

Suction type CH₄ detector head

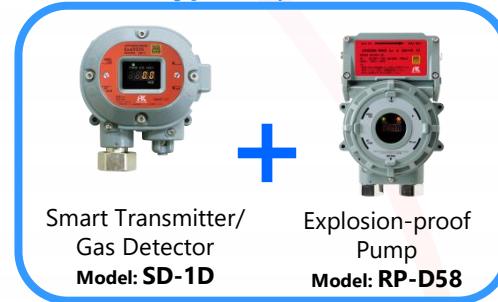

Personal combustible gas detectors for workers



4. Biogas power generation

Description: Biogas power generation systems extract combustible biogas (methane) from fermented organic waste material (e.g., cattle manure, waste food material, sewage); this biogas drives gas engines or gas turbines to generate electricity.

Hazardous risks: CH₄ leaks inside the biogas generator chamber pose explosion risk.

⇒ Detecting CH₄ to prevent explosions

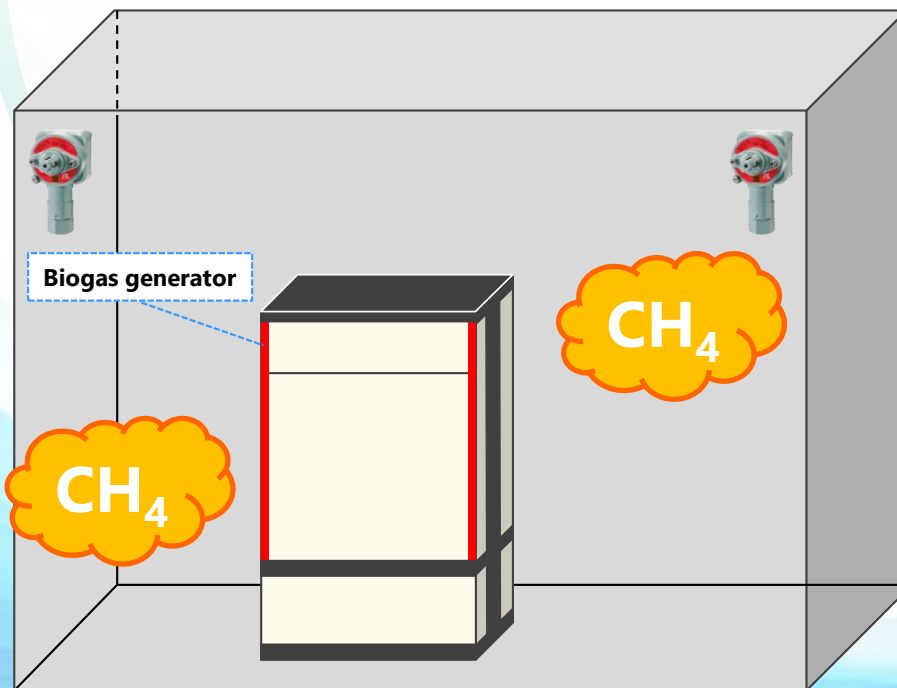

Biogas generator chamber

CH₄ detector head



5. Wood biomass gasification power generation

Description: Wood biomass gasification power generation generates electricity by converting wood chips and similar materials into gas at high temperature, and then burning this gas in a gas engine or gas turbine.

Hazardous risks: CO leaks inside the wood biomass gasification furnace, gas engine, or gas turbine enclosure pose poisoning risk.

⇒ Detecting CO to prevent poisoning

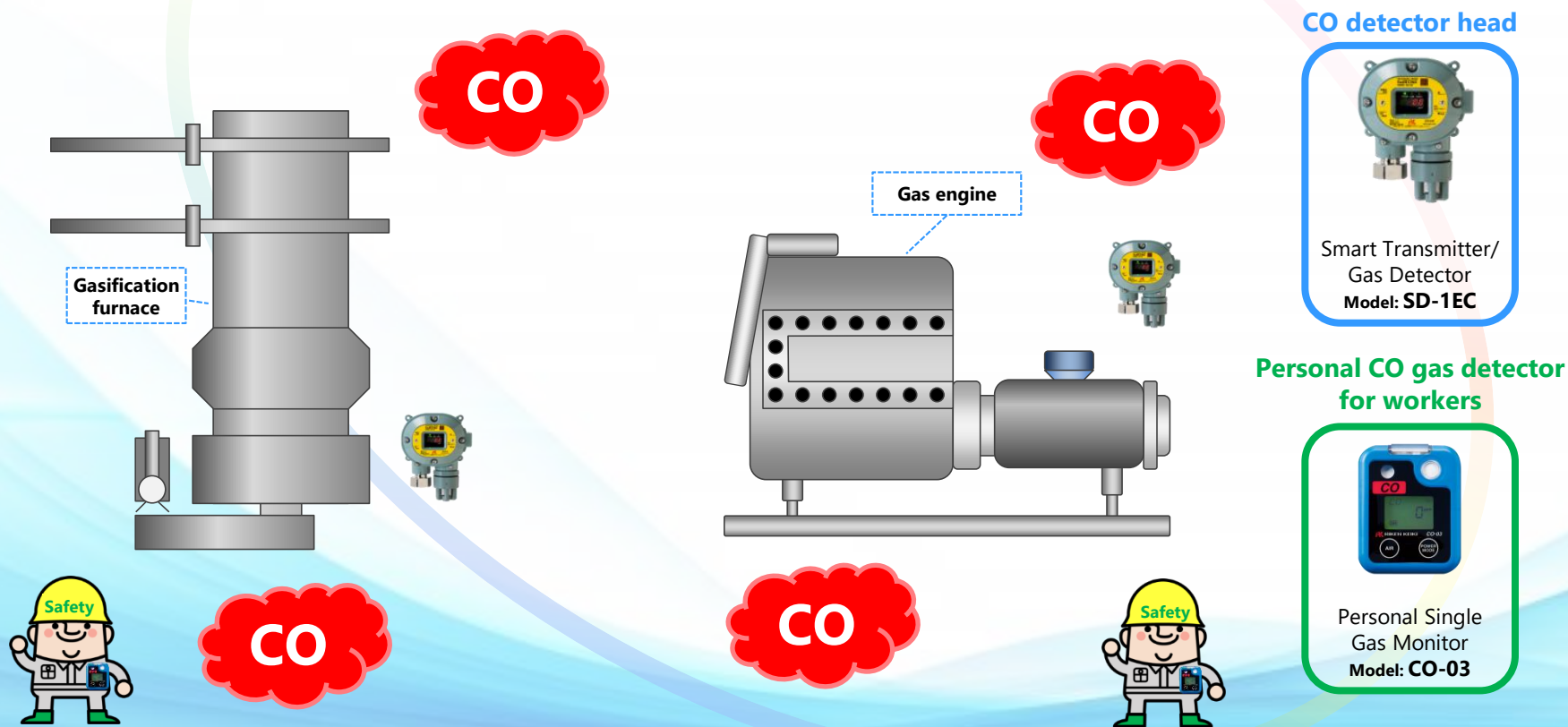

6. Geothermal power generation

Description: Geothermal power generation generates electricity by extracting geothermal fluid from geothermal reservoirs*, vaporizing the geothermal fluid in a separator (moisture separator), and using the geothermal fluid to vaporize a secondary medium to generate steam. The steam thus generated then rotates a turbine to generate electricity. Geothermal fluid contains various substances, including carbon dioxide (CO₂), hydrogen sulfide (H₂S), ammonia (NH₃), methane (CH₄), and sulfur dioxide (SO₂), a volcanic gas.

* Layer far below the earth's surface in which rain and snow that seep down are trapped as high-temperature fluid (geothermal fluid)

Hazardous risks: H₂S or SO₂ leaks in the condenser pit, electrical room, culvert, or other areas at the geothermal power generation station pose risk of poisoning.

⇒ Detecting H₂S and SO₂ to prevent poisoning

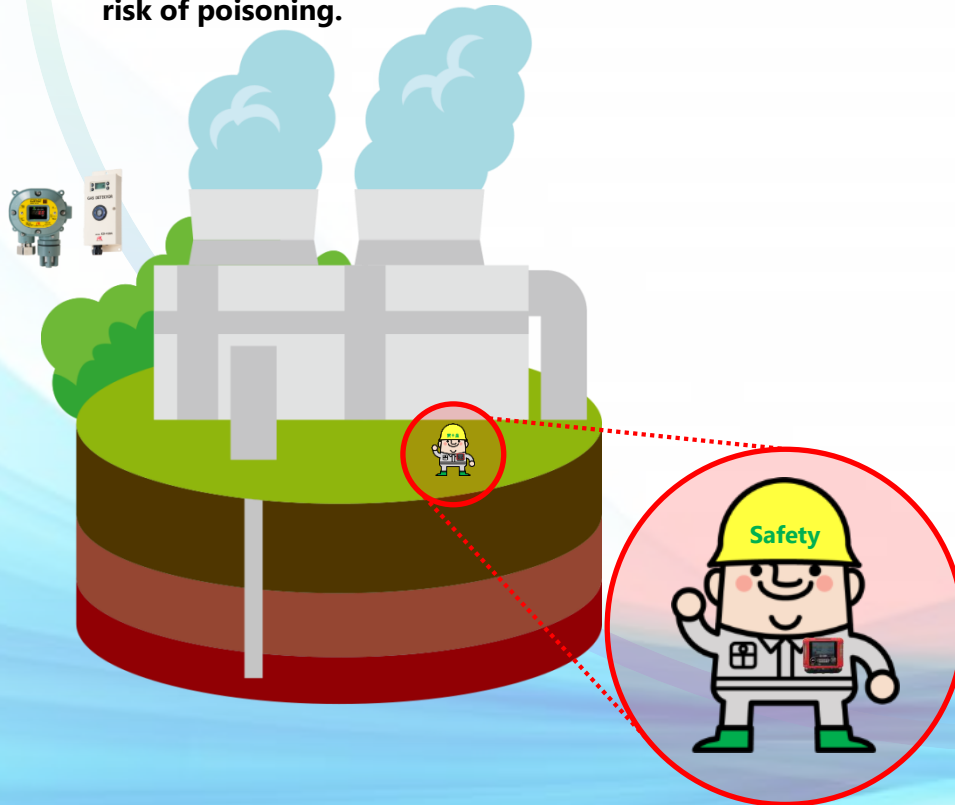

H₂S/SO₂ detector heads



Smart Transmitter/
Gas Detector
Model: SD-1EC



Toxic Gas Detector
Head
Model: GD-K88Ai

Pre-work gas detector

Personal H₂S/SO₂ gas detector for workers



Portable Multi
Gas Detector
Model: GX-6000



Four Gas Personal
Monitor
Model:
GX-2009 TYPE J



RIKEN KEIKI

Major Examples of Accidents

Prepared by extracting and processing materials from the Safety at Work Site
(Ministry of Health, Labour and Welfare: <http://anzeninfo.mhlw.go.jp/index.html>)

Case of organic solvent poisoning during paint repair work at a hydroelectric power station

Figure: Schematic view of power station

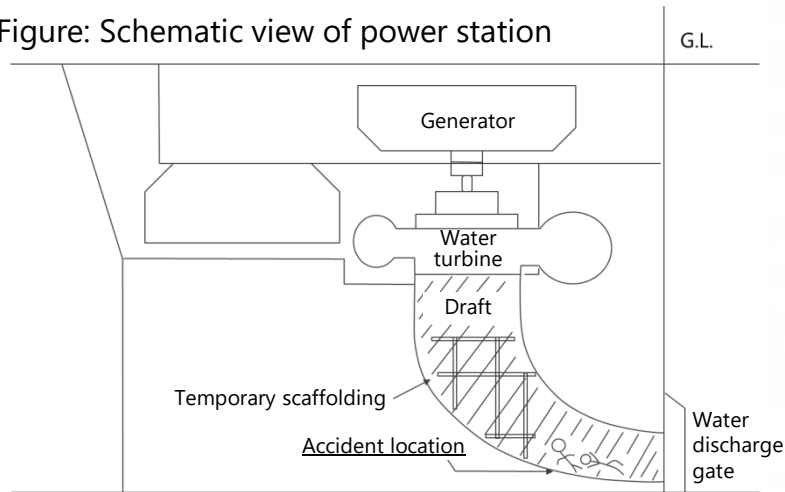

[Location of accident]

Water channel ("draft") leading to a water discharge gate for water exiting the water turbine at a hydroelectric power station

[Cause of accident]

The interior of the draft was repainted during periodic maintenance. When unpainted and poorly painted locations were subsequently discovered, workers entered the draft to finish the painting work. One worker subsequently collapsed inside the draft, while the other was rendered immobile.

[Damage/injuries]

The workers were taken to hospital, where they were diagnosed with organic solvent poisoning.



Wearing gas detectors on a routine basis enables early detection of toxic gas leaks and improves work safety.

Case involving fire at the top of a desulfurization tower at a power generating facility

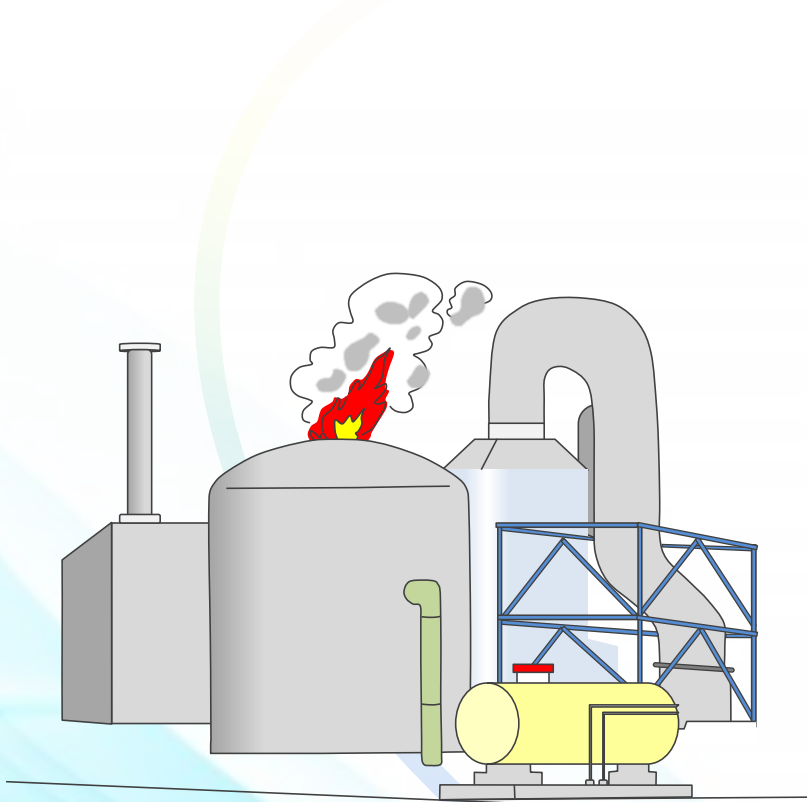

[Location of accident]

Desulfurization tower at a gas turbine power generating facility

[Cause of accident]

Following periodic maintenance at the power generating facility, the exhaust gas temperature at the desulfurization tower outlet rose steadily due to the factors listed below. The temperature eventually exceeded 200°C, at which point the polypropylene demister at the top of the desulfurization tower caught fire.

1. A test run was done with the sealing water injection valve on the cooling water circulating pump closed.
2. The test run was resumed without checking the effects on other equipment in the vicinity after a fault was detected.
3. The appropriate measures were not checked when faults occurred during regular operation.

[Damage/injuries]

No resulting injuries to personnel



Wearing gas detectors on a routine basis enables early detection of toxic gas leaks and improves work safety.

Case involving hydrogen sulfide poisoning during sludge removal inside a thermoelectric power station

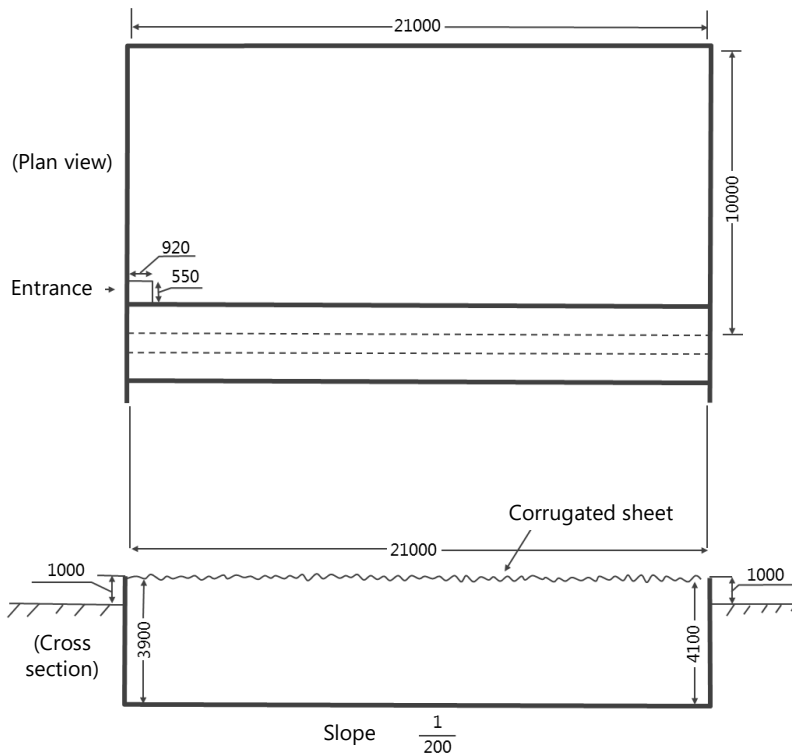

[Location of accident]

Inside a circulating water receiving tank inside a thermoelectric power station

[Cause of accident]

While removing sludge from inside a circulating water receiving tank, a worker inhaled hydrogen sulfide from the sludge, suddenly lost consciousness, and collapsed. A worker who entered the tank to rescue the victim also inhaled hydrogen sulfide, lost consciousness, and collapsed.

[Damage/injuries]

Workers wearing oxygen tanks and breathing apparatus entered the tank and rescued the two victims. Hydrogen sulfide concentrations measured at the same location where it had been measured before work began exceeded 100 ppm.



Wearing gas detectors on a routine basis enables early detection of toxic gas leaks and improves work safety.

Case involving hydrogen sulfide poisoning during inspection of an oil separation vessel at a geothermal power station



[Location of accident]

Inside an oil separation vessel chamber in a geothermal power station

[Cause of accident]

Steam, after being fed to the turbine inside a power station, contains oil when it is discharged to the atmosphere via an air pump because the air pump uses lubricating oil. Oil and moisture in this exhaust gas (steam) are separated out in a drain tank and transferred to an oil separation vessel. A worker involved in scooping out oil from the separation vessel was found collapsed and unresponsive at the bottom of the access ladder.

[Damage/injuries]

The worker was taken to hospital but was declared dead on arrival. A post mortem examination at the hospital revealed sulfides in the worker's lungs, thigh muscles, brain, heart, liver and blood. The cause of death was determined to hydrogen sulfide poisoning.



Wearing gas detectors on a routine basis enables early detection of toxic gas leaks and improves work safety.

Product Information



RIKEN KEIKI



SD-1

SD-1RI

(For combustible
gases)

SD-1GH

(For combustible/
toxic gases)

SD-1EC

(For carbon
monoxide/hydrogen
sulfide)

SD-10X

(For oxygen)

Smart Transmitter/
Gas Detectors

Model:

SD-1 series

Features

- Explosion-proof products that can be used in hydrogen/acetylene atmospheres
- Waterproof/dustproof enclosure (IP 65 equivalent) allows deployment in severe environments.
- Supports HART Communication Protocol, allowing transmission of more information over legacy analog 4-20 mA connections.
- * Excluding SD-1 (TYPE NC)
- SD-1RI, SD-1EC, and SD-10X are SIL 2 certified in all parts of the functional safety standard, marking a first for Japanese manufacturers.
- Using the suction cap for the SD-1 series and connecting the detector to a suction pump or an aspirator unit enables suction type operation.



SDWL-1RI

(For combustible gases)



SDWL-1EC

(For carbon monoxide/
hydrogen sulfide)



SDWL-10X

(For oxygen)

Features

- Wireless transmission function makes these products ideal for improving safety management in locations where wiring presents problems.
 - Conforms to ISA 100.11a standard specification, enabling connection to other manufacturers' instruments.
 - Battery pack completely eliminates wiring. Fully standalone
 - Mounting configuration allows easy installation anywhere. (with dedicated mounting bracket)
 - Pressure resistant and inherently safe explosion-proof construction
- * TIIS explosion-proof certification pending

Fixed Wireless
Gas Detectors

Model:

SDWL-1 series



RIKEN KEIKI



SD-D58

(With concentration indicator)



GD-D58

(Without concentration indicator)

Explosion-proof Suction
Type Gas Detector

Model: SD-D58

Model: GD-D58

Features

- Explosion-proof products that can be used in hydrogen atmospheres
- Equipped with automatic flow rate abnormality detection function
- Integrated assemblies of replacement parts improve maintainability.
- Dustproof/waterproof enclosure (IP 67 equivalent)
- One-person maintenance possible
- The RP-D58 is also provided as an explosion-proof pump.



RIKEN KEIKI



GD-A80

(For combustible gases)



GD-A80V

GD-A80S*

(For combustible or toxic gases)

* The GD-A80S nameplate is blue.

Features

- Explosion-proof rating Exd II CT4 allows use in hydrogen and acetylene atmospheres.
- Suction type and aspirator suction type operations are supported.
(* A pump unit and a power supply [available separately] are required.)
- The GD-A80-70 is also provided as a combustible gas detector head for use in high-temperature environments up to 70°C (normally 53°C).

Combustible/Toxic
Gas Detector Heads

Model:

GD-A80 series



RIKEN KEIKI



Features

- Two-wire gas detector head
Allows direct transmission to the control system.
- Equipped with pressure correction sensor that provides consistent readings under fluctuating atmospheric pressures (GD-F88Ai, GD-F88Di)
- Built-in aspirator (optional)
Conventional external unit replaced by built-in unit (GD-K88Ai, GD-K88Di)
- Corrosive gas resistant enclosure
SUS enclosure available at customer request
- Intrinsically safe explosion-proof enclosure combined with safety barrier

[Diffusion type]

GD-K88Ai (for toxic gases)

GD-F88Ai (for oxygen)

[Suction type]

GD-K88Di (for toxic gases)

GD-F88Di (for oxygen)

Intrinsically safe explosion-proof enclosure
Oxygen/Toxic Gas Detector Heads

Model: **GD-88** series



RIKEN KEIKI



Explosion-proof Calorimeter

Model:
OHC-800

Features

- Incorporates Riken Keiki's unique "optsonic" calculation method (Japanese Patent No. 518483). Resistant to influence from incombustible gases for high-precision measurements
- Fast response at 90% response within 5 seconds
- High repetition accuracy within ± 0.02 MJ/m³
- Hydrogen explosion-proof enclosure (Exd IIB + H₂T4) required for calorimeters allows installation in dangerous areas.
- Excellent temperature characteristics, with temperature change of 0.10 MJ/m³ or less per day
- Calorific value/specific gravity/Wobbe index switchable with key operation, eliminating troublesome calculations



RIKEN KEIKI



Multi-case



Single case

Features

- System options include a wide range of gas detector heads.
- Gas concentrations are displayed in two ways: bar meter and digital display.
- High-contrast three-color LCD improves visibility of detected state.
- Equipped with RS-485 communication function (optional)

Multi-channel Gas Monitoring Systems

Model:

RM-5000 series



RIKEN KEIKI



Features

- Capable of measuring with small gas amounts
Measures with small gas amounts.
Typical gas consumption: approx. 62.5 ml (sample pressure 0.7 MPa)
- Simple and easy operation
Allows straightforward measurement without pressure or flow rate adjustments.
- Data logger function
Capable of recording up to 256 entries for date, time, and measured gas concentrations
- Compact design
A compact carrying case construction makes it easy to carry the device.

SF6 Purity Meter

Model:

FI-8000-SF6



Portable
Multi Gas Monitor

Model:
GX-8000

Features

- Compact, lightweight design for portability
- Hydrogen explosion-proof compliance to Exia II CT4X rating
- Protection rating equivalent to IP 67 for peace of mind even in harsh environments
- Powerful suction using high-flowrate pump
- Large, easy-to-read display with backlight
- Bright, easy-to-see lamps and loud buzzer for high audibility
- Concentration displayed simultaneously by both digital readout and analog bar meter
- Can be used with dedicated waist belt (optional) for improved wearability and stability during work

Type list

Components	Type	Gas types
5-component	TYPE A	HC/CH ₄ (%LEL, vol%), O ₂ , H ₂ S, CO
4-component	TYPE B	HC/CH ₄ (%LEL), O ₂ , H ₂ S, CO
3-component	TYPE C	HC/CH ₄ /C ₂ H ₂ (%LEL), O ₂ , H ₂ S
	TYPE D	HC/CH ₄ (%LEL), O ₂ , CO
	TYPE E	HC/CH ₄ /H ₂ (%LEL, vol%), O ₂
2-component	TYPE F	HC/CH ₄ /C ₂ H ₂ (%LEL), O ₂
	TYPE G	H ₂ (%LEL), O ₂



RIKEN KEIKI



Portable Toxic Gas Monitor

Model:
SC-8000

Features

- Intrinsically safe explosion-proof enclosure
- Extensive gas compatibility lineup
- Dustproof/waterproof enclosure allows use anywhere
- Variable buzzer volume function
- Two easy-to-read display indicators (digital/analog)
- Selectable target gases



RIKEN KEIKI



Portable HC/O₂ Gas Detector

Model:
RX-8000

Features

- Intrinsically safe explosion-proof enclosure with Exia II CT4X explosion-proof rating
Suitable for use even in Zone 0 Hazardous Areas.
- Features high-precision infrared sensor capable of consistently high precision measurements, even in environments with inert gases or N₂.
- Capable of measuring from high concentrations (vol%) to low concentration (%LEL).
- Features auto range selection to eliminate manual operation.
- Runs on environmentally-friendly lithium-ion rechargeable batteries.
- Large LCD display with backlight for easy viewing, even in direct sunlight
- Gas concentrations are simultaneously indicated by digital readout and on an analog bar meter.



RIKEN KEIKI

Portable
Multi Gas Detector

Model:
GX-6000



Features

- A single unit can simultaneously display up to six types of gases, including VOCs. This product is the first of its kind from a Japanese manufacturer.
- The PID sensor enables measurements of more than 200 types of target chemical substances.
- Ideal for checking the risks and hazards of chemical substances as required under the Industrial Safety and Health Act
- Support for multilingual display (Japanese, English, French, Spanish, etc.)
- Equipped with convenient new functions, including panic alarm and LED flashlight



Portable
Gas Leak Checker

Model: SP-220 TYPE H2

Features

- Compact and lightweight! Tough, stylish exterior
- Quickly and reliably detects low hydrogen concentrations.
- Reads out gas concentrations at the press of a button.
- Incorporates data logger function capable of recording up to 256 entries for date, time, and measured gas concentrations.
- LED lighting allows accurate measurement even in dark locations.



Portable
Combustible Gas Detector

Model:
GP-1000

Features

- A single unit with a gas type switching function can detect 25 types of combustible gases.
- The intrinsically safe explosion-proof enclosure (explosion-proof rating: Exia II CT4) enables measurement in Zone 0 Hazardous Areas exposed to constant risk of explosions.
- Protection rating equivalent to IP 67 ensures secure outdoor work.
- Once a cartridge-type filter (available separately) is attached to the standard probe, the probe can be customized for hydrogen sulfide removal or silicon removal depending on the measurement environment.



Portable
Combustible Gas Detector

Model:
NC-1000

Features

- Measures all types of combustible gases to orders of ppm concentration.
- A single unit with a gas type switching function can detect 25 types of combustible gases.
- Includes pump booster feature to provide suction force even over long distances. (Suction flow rate: 0.3 L/min \Rightarrow 0.6 L/min)
- The range display switches automatically (between Low and High) to suit the measurements.
- Once a cartridge-type filter (available separately) is attached to the standard probe, the probe can be customized to suit the measurement environment (e.g., hydrogen sulfide or silicon removal).



Four Gas Personal Monitor

Model: GX-2009

Features

- Explosion-proof product that can be used in hydrogen/acetylene atmospheres
- Protection rating equivalent to IP 67 ensures safe use for outdoor work.
- Three-direction alarm lamps and two-direction alarm buzzers to alert both the carrier and those in surrounding areas
- Buzzer volume of 95 dB or more can be clearly heard even in noisy factory environments.
- Simultaneous display of gas concentrations of up to four components on large LCD screen
- Also equipped with clock display and data logger functions

Type list

Components	Type	Gas types
4-component	TYPE A	O ₂ , LEL, H ₂ S, CO
3-component	TYPE B	O ₂ , LEL, H ₂ S
	TYPE C	O ₂ , LEL, CO
2-component	TYPE D	O ₂ , LEL
	TYPE E	O ₂ , H ₂ S
	TYPE F	O ₂ , CO
	TYPE I	LEL, CO



RIKEN KEIKI



GP-03

(For combustible gases)

OX-03

(For oxygen)

HS-03

(For hydrogen sulfide)

CO-03

(For carbon monoxide)

Personal
Single Gas Monitors

Model:

03 series

Features

- Models powered by rechargeable batteries have been added to the product line.
- Standard protective cover protects the main unit from scratches, dirt, and impact.
- Compact, lightweight design doesn't interfere with work.
- Inherently safe and explosion-proof enclosure is ideal for use in hazardous locations.

International Agents

International Agents



North America

South America

Asia and Pacific

Russia and Central Asia

Europe

Middle East

Africa

International agents (table of contents)

North America

U.S.A.

South America

Brazil

Argentina

Peru

Chile

Uruguay

Asia and Pacific

China

South Korea

Taiwan

Singapore

Malaysia

Indonesia

Thailand

India

Vietnam

Philippines

Australia

Europe

Germany

Greece

THE NETHERLANDS

Norway

Turkey

U.K.

Middle East

U.A.E.

Israel

Africa

South Africa

Russia and Central Asia

Russia

International agents (U.S.A.)

RKI INSTRUMENTS, INC.

ADDRESS : 33248 CENTRAL AVENUE, UNION CITY, CA94587-2010 U.S.A.

TEL : +1-510-441-5656

FAX : +1-510-441-5650

E-MAIL : bob@rkiinstruments.com, sandra@rkiinstruments.com

PERSON : MR. BOB PELLISSIER (PRESIDENT)
MRS. SANDRA GALLAGHER (VICE PRESIDENT)

WEBSITE : <http://www.rkiinstruments.com/>

International agents (BRAZIL)

HIDEO NAKAYAMA IMP. EXP. COM. E INDUSTRIA LTDA

ADDRESS : RUA SANTA AMÉLIA, 33 PRACA DA BANDEIRA
RIO DE JANEIRO RJ CEP: 20.260-030 BRAZIL

TEL : +55-21-2590-3496

FAX : +55-21-2270-6390

E-MAIL : hideko@nakayama.com.br

PERSON : MR. HIDEO NAKAYAMA (PRESIDENT)
MS. HIDEKO NAKAYAMA

WEBSITE : <http://www.nakayama.com.br/>



International agents (ARGENTINA)

Prevent Gas SA

ADDRESS : INCLAN 4185 (C1258ABK) CIUDAD DE BUENOS AIRES, ARGENTINA
TEL : +54-11-4925-6342
FAX : +54-11-4925-6342
E-MAIL : ventas@preventgas.com.ar
PERSON : Mr. German Rosas
WEBSITE : <http://preventgas.com.ar/>

HUBERG SUDAMÉRICA S.A.

ADDRESS : ERASMO (CALLE 79) 1047 (B1650HOE) VILLA PIAGGIO
SAN MARTÍN, BUENOS AIRES, ARGENTINA
TEL : +54-11-4713-6068
FAX : +54-11-4713-6072
E-MAIL : arguello.juan@huberg.com
PERSON : MR. JUAN IGNACIO ARGUELLO
WEBSITE : <http://www.huberg.com.ar>



International agents (PERU)

RESET ELECTRONICA Y SISTEMAS S.R.L.

ADDRESS : Calle Martin de Murua 150 Of. 1004 - 1005
Edificio Plexus San Miguel Business Center
San Miguel - Lima 32, PERU

TEL : +51-1-6367303

FAX :

E-MAIL : enquiries@resetnaval.com

PERSON : Mr. Max Muñoz Moran

WEBSITE : <http://www.resetnaval.com/>

International agents (CHILE)

Electronic Marine Ltd

ADDRESS : Uruguay 556 of 404 Valparaiso, CHILE
TEL : 56-32-2220050
FAX : 56-32-2593135
E-MAIL : marketing@electronicmarine.cl
PERSON : Alejandra Palominos (Marketing Manager)
WEBSITE : <http://www.electronicmarine.cl>

International agents (URUGUAY)

microsur

ADDRESS : Carlos María Morales 934, 11200 Montevideo, Uruguay

TEL : 598-2410-1128

FAX : 598-2410-1128

E-MAIL : microsur@microsur.org

PERSON : Dra.Nermys Hernandez

WEBSITE : <http://www.microsur.org>

International agents (CHINA)

RIKEN KEIKI COMMERCIAL(SHANGHAI) CO., LTD.

ADDRESS : HEAD OFFICE : ROOM4A SHANGHAI WATANABE INTERNATIONAL
COMMERCIAL BUILDING NO.55, LINPING N.ROAD, HONGKOU DISTRICT,
SHANGHAI, 200086 CHINA

SALES DEPARTMENT OFFICE : ROOM1106 DALIAN LEE WAN HOTEL NO.8,
MINZHU SQUARE, ZHONGSHAN DISTRICT, DALIAN, LIAONING, 116001
CHINA

TEL : 86-411-8212-3832

FAX : 86-411-8212-3833

E-MAIL : dl@rkkc.net (Ms. Sun Jun)
dl101@rkkc.net (Ms. Qu shuai)
dl102@rkkc.net (Ms. Xu fei)

WEBSITE : <http://www.rikenkeiki.asia>

International agents (KOREA)

RIKEN KEIKI KOREA CO., LTD.

ADDRESS : 23, HWAJEONSANDAN 2-RO 134,
GANGSEO-GU, BUSAN, 46741 KOREA
TEL : 82-51-712-9900 FAX: 82-51-518-7736
E-MAIL : master@rikenkeiki.co.kr PERSON: MR.SUN-GU,LEE
WEBSITE :
(KOREAN) <http://rikenkeiki.co.kr/bn/>
(ENGLISH) <http://rikenkeiki.co.kr/bn/english/>

HIGH INTEGRATED TECHNOLOGY, INC.

ADDRESS : 72, SEGYOSANDAN-RO, PYEONGTAEK-SI,
GYEONGGI-DO, 17843, KOREA
TEL : 82-31-650-7000 FAX: 82-31-650-7007
E-MAIL : info@hitinc.co.kr PERSON: MR.HYUNG-SIL, KIM
WEBSITE :
(KOREAN) <http://www.hitinc.co.kr/>
(ENGLISH) http://www.hitinc.co.kr/?strMode=company_e/company



International agents (TAIWAN)

RIKEN KEIKI TAIWAN CO., LTD. HEAD OFFICE

ADDRESS : NO.87, YANGMING RD., SHANHUA JEN, TAINAN, 741, TAIWAN
TEL : 886-6-581-1224
FAX : 886-6-581-1250
E-MAIL : episys@ms22.hinet.net
PERSON : MR. SEITARO TAKAHASHI (PRESIDENT)
WEBSITE : <http://www.rikenkeiki.com.tw/admin/news/front/news.php>

RIKEN KEIKI TAIWAN CO., LTD. TAICHUNG BRANCH

ADDRESS : NO.2, ALY.14, LN.150-30, SEC.3, XITUN RD., XITUN DIST., TAICHUNG CITY 407,
TAIWAN
TEL : 886-4-2462-5386
FAX : 886-4-2462-5508
E-MAIL : johnny@rikenkeiki.com.tw
PERSON : MR. WU WEN CHENG

International agents (SINGAPORE)

R K INSTRUMENTS (S) PTE LTD

ADDRESS : 102F PASIR PANJANG ROAD #03-11, CITILINK WAREHOUSE COMPLEX
SINGAPORE 118530

TEL : 65-6275-3398

FAX : 65-6275-3387

E-MAIL : rk@rkinstruments.com.sg

PERSON : MR. BERNARD QUEK (PRESIDENT)

WEBSITE : <http://www.rkinstruments.com.sg/>



International agents (MALAYSIA)

KINETICS SYSTEMS MALAYSIA SDN. BHD.

ADDRESS : 12A, JALAN RINGGIT 23/11 , SECTION 23, 40300 SHAH ALAM, SELANGOR
DARUL EHSAN MALAYSIA

TEL : 603-5542-2288

FAX : 603-5542-2289

E-MAIL : ck.chooi@kinetics.net

PERSON : MR. CHOOI CHOON KEET
(GENERAL MANAGER)

WEBSITE : <http://www.kinetics.net/>



International agents (INDONESIA)

PT. PRATAMA GRAHA SEMESTA

ADDRESS : KOMPLEKS LODAN CENTER BLOK H-11 JL. LODAN RAYA NO.2 ANCOL - PADEMANGAN
JAKARTA UTARA 14430 INDONESIA

TEL : 62-21-6900656

FAX : 62-21-6900657

E-MAIL : sales@ptpgs.co.id

PERSON : MR. FRENGKY TOMBOKAN



PT. CENTRADINDO UNITRAS (FOR PERTAMINA & MARINE SECTOR)

ADDRESS : COMPLEX PERKANTORAN DUTA HARAPAN INDAH JL. KAPUK MUARA RAYA BLOK SS
NO.3 JAKARTA UTARA 14460 INDONESIA

TEL : 62-21-6624347

FAX : 62-21-6623594

E-MAIL : centradindo.unitras@gmail.com

PERSON : MR. DJOHAN DAHLIAN (MANAGING DIRECTOR)

International agents (THAILAND)

TAIYO GASES CO., LTD.

ADDRESS : 17TH FLOOR SERM-MIT TOWER, 159 SUKHUMVIT 21 ROAD, NORTH
KLONGTOEY, WATTANA, BANGKOK 10110 THAILAND

TEL : 66-2-260-2691

FAX : 66-2-260-2690

E-MAIL : hato@taiyogases.th.com

PERSON : MR. KAZUNARI HATO

WEBSITE : <http://www.taiyogases.th.com/>

International agents (INDIA)

TRITECH

ADDRESS : 121,VEENA INDUSTRIAL ESTATE, OPP.FITWELL HOUSE, L.B.S.MARG,
VIKHROLI(W) MUMBAI-400 083 INDIA

TEL : 91-22-2577-7288, 6796-9990

FAX : 91-22-6796-9991

E-MAIL : tritec@vsnl.com

PERSON : MR. NARESH SHARMA MR. JIGNESH SHAH

WEBSITE : <http://www.tritech.in/>



International agents (VIETNAM)

VIETNAM GAS DETECTOR ONE MEMBER CO., LTD.

ADDRESS : 79 Ly Chinh Thang St, ward 8, Dist 3, HCMC, Vietnam

TEL : +84-(0)28-35262986 / 35262987

FAX : +84-(0)28-35262980

E-MAIL : info@vina-gasdetector.vn

PERSON : MR. CAO MINH LOI (Director)

WEBSITE : <http://vina-gasdetector.vn/>



International agents (PHILIPPINES)

PILIPINAS TRADE GAS, INC. (PTGI)

ADDRESS : 23RD FLOOR ONE CORPORATE CENTER DONA JULIA VARGAS AVE.,
CORNER MERALCO AVENUE, ORTIGAS CENTER PASING CITY,
PHILIPPINES

TEL : 632-635-7320

FAX : 632-635-7322

E-MAIL : gerry.gueco@yahoo.com.ph

PERSON : MR. S. HARA (PRESIDENT)
MR. GERRY C. GUECO (IN CHARGE)



International agents (AUSTRALIA)

CONTROL EQUIPMENT PTY. LTD.

ADDRESS : UNIT 1/3 DEAKIN STREET, BRENDALE QLD 4500, AUSTRALIA

TEL : 61-7-3481-9000

FAX : 61-7-3481-9088

E-MAIL : sales@controlequipment.com.au

PERSON : MR. GREG LOVE (GENERAL MANAGER)

WEBSITE : <http://www.controlequipment.com.au/>



International agents (GERMANY)

RIKEN KEIKI GmbH

ADDRESS : Theodor-Heuss-Allee 112, 60486 Frankfurt am Main, Germany

TEL : +49-6966-7741-460, 461

E-MAIL : s-ono@rikenkeikigmbh.de

PERSON : MR. SHINTARO ONO(Managing Director)

WEBSITE : <http://www.rikenkeiki.com/de/>



International agents (GREECE)

ZERVOUDAKIS MARINE SUPPLIES LTD.

ADDRESS : 31, MILOU STREET, PIRAEUS 18545, GREECE

TEL : +30-210-4623700

FAX : +30-210-4627900

E-MAIL : zerv@otenet.gr

PERSON : MR. JOHN ZERVOUDAKIS

WEBSITE : <http://www.zervoudakis.gr/>



International agents (THE NETHERLANDS)

GMS Instruments B.V.

ADDRESS : Driemanssteeweg 190, 3084 CB, Rotterdam, The Netherlands

TEL : +31102938860

E-MAIL : sales@gms-instruments.nl

PERSON : MR. SEBASTIAN KELDERMAN AND MR. MARKUS FRANK

WEBSITE : <http://gms-instruments.nl/>

International agents (NORWAY)

MARTIN BRUUSGAARD & CO. AS.

ADDRESS : LOKKETANGEN 20A, 1337 SANDVIKA NORWAY
P.O. BOX 3, 1301 SANDVIKA NORWAY

TEL : +47-6754-9330

FAX : +47-6754-9331

E-MAIL : dag@bruusgaard.no

PERSON : MR. DAG MAARTMANN

WEBSITE : <http://www.bruusgaard.no/>



International agents (TURKEY)

DOGANAK COLL. CO.

ADDRESS : KARAKOY, OKCUMUSA CADDESİ, IPEK ÇIKMAZI,
BOGAZICI HAN NO:6 KAT:2
34420 ISTANBUL, TURKEY

TEL : +90-212-244-5318 / 245-2512

FAX : +90-212-243-5704

E-MAIL : doganak@doganak.com

PERSON : MR. MEHMET ALI AKYUZ

WEBSITE : <http://www.doganak.com/>



International agents (U.K.)

WEATHERALL EQUIPMENT & INSTRUMENTS LTD.

ADDRESS : UNIT 1 STATION APPROACH, WENDOVER AYLESBURY,
BUCKS HP22 6BN ENGLAND

TEL : +44 1296 622180

FAX : +44 1296 624955

E-MAIL : sales@weatherall-uk.com

PERSON : MR. R.H.C. WORTHINGTON

WEBSITE : <http://weatherall-uk.com/>



International agents (U.A.E.)

METRO MAC

ADDRESS : WS 104, DUBAI MARITIME CITY (DMC), DUBAI, U.A.E.
P.O.BOX: 13485 DUBAI U.A.E.

TEL : +971-4-5636100

FAX : +971-4-5519973

E-MAIL : sales@metromac.com

PERSON : MR. K.K. KUTTY
(MANAGING DIRECTOR)

WEBSITE : <http://www.metromac.com/>



International agents (ISRAEL)

MODCON SYSTEMS LTD.

ADDRESS : MODCON HOUSE M. BORNSHTEIN ST.,
SOUTH AKKO INDUSTRIAL PARK, 24222 ISRAEL

TEL : +972-4-9553955

FAX : +972-4-9553956

E-MAIL : gregorys@modcon.co.il

PERSON : MR. GREGORY SHAHNOVSKY

WEBSITE : <http://www.modcon-systems.com/>



International agents (SOUTH AFRICA)

I.S.L. ENTERPRISES (PTY) LTD.

ADDRESS : 29 KLOSSER STREET PAROW 7500 SOUTH AFRICA
P.O.BOX 72 PAROW 7499 SOUTH AFRICA

TEL : +27-21-930-2354

FAX : +27-21-930-2043

E-MAIL : istvanisl@xsinet.co.za

PERSON : MR. I.S. LADANYI



International agents (RUSSIA) **TAIRIKU TRADING CO., LTD.**

ADDRESS : Head office in Tokyo, Japan KAJITANI DAIICHI BUILDING, 21-10,
SHINKAWA 2-CHOME, CHUO-KU, TOKYO 104-0033, JAPAN

TEL : +81-3-6222-0194 FAX: +81-3-6222-0201

E-MAIL : tairiku@tairiku-trading.co.jp

PERSON : MR. MORITA

WEBSITE : <http://www.tairiku-trading.co.jp/?lang=en>

OOO"TAIRIKU MOSCOW LTD."

ADDRESS : RUSSIAN FEDERATION, 119049,
MOSCOW, KOROVY VAL STREET,7,
BUILDING 1, FLOOR 2,OFFICE 12

TEL : +7-495-237-18-82 +7-495-237-19-26

FAX : +7-495-931-99-47

E-MAIL : tairiku.alpeev@co.ru, ofistrk@online.ru

PERSON : MR. ALPEEV M.A., (MANAGER)

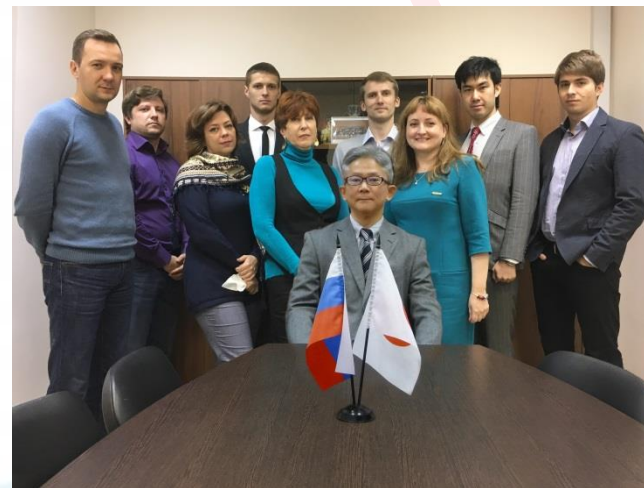



RIKEN KEIKI

*We are a **pioneer** in creating **safe working** environments for workers.*